



*closing the loop on thermal solutions*

# **Resistance Temperature Detectors**

## **INTRODUCTION**

For high-accuracy temperature measurements in a variety of industrial and commercial air and gas applications, Durex Industries offers RTD's of multiple elements and styles. Durex RTD's are available with an assortment of connections, mounting hardware, and enclosures to suit harsh chemical, immersion, and other heavy-duty requirements. Sealed leadwire transitions eliminate contamination. Multiple sensing elements can be located at various points for precise temperature control.



### **Design Features:**

- Platinum, Nickel, or Nickel Iron elements
- 2, 3, or 4-wire styles
- High pressure applications up to 5000 psi
- Optional sanitary-grade stainless steel hardware
- Temperatures up to 1500°F (816°C)
- Optional braiding or armor cable shielding

### **Typical Applications:**

- Food Service
- Semiconducting
- Packaging
- Hot Melt Dispensing
- Vacuum Sealing and Forming
- Automotive
- Medical / Laboratory Settings



*closing the loop on thermal solutions*

# **Resistance Temperature Detectors**

## **SPECIFICATIONS**

Unless otherwise specified, Durex's RTD assemblies include photo-lithographically structured, high-purity platinum thin-film elements laser trimmed to precise resistance values. These sensors feature brief response times, excellent long term stability, low self heating and excellent resistance to vibration and temperature shocks.

### **Thermal Response Time**

The response time  $T_{0.63}$  is the time the sensors need to respond to 63% of the change in temperature. The response time depends on the sheath dimensions, but can be as low as 1.2 seconds.

### **Long Term Stability**

The change of ohmage after 1,000 hours at maximum operating temperature amounts to less than 0.03%.

### **Self Heating**

To measure the resistance, an electric current has to flow through the element, which will generate heat energy resulting in errors of measurement. To minimize error, the testing current should be kept low (approximately 1mA for Pt-100).

Temperature error  $\Delta T = RI^2/E$  with:

E = self-heating coefficient in mW/K

R = resistance in k $\Omega$

I = measuring current in mA

The self-heating coefficient (E) for the standard elements used in Durex RTD assemblies is 4 mW/K in air and 40 mW/K in water.

### **Measuring Current**

Measurement current causes heating of the platinum thin-film sensor. The resulting temperature error is given by:  $\Delta T = P/E$  with the power loss  $P = I^2R$ , and the self-heating coefficient E in mW/K.

The amount of thermal transfer from the sensor in the application determines how much measuring current can be applied. There is no bottom limit of the measurement current with platinum thin-film. The measurement current depends highly on the application in use.

We recommend at:

100 $\Omega$ : typically 1mA, maximum 5mA

500 $\Omega$ : typically 0.5mA, maximum 3mA

1000 $\Omega$ : typically 0.3mA, maximum 2mA

2000 $\Omega$ : typically 0.2mA, maximum 1mA

### **Nominal Values**

The nominal or rated value of the sensor is the target value of the sensor resistance at 0°C. The temperature coefficient  $\alpha$  is defined as  $\alpha = \frac{R_{100} - R_0}{100 - R_0}$  ( $K^{-1}$ ) and has the numerical value of 0.00385  $K^{-1}$  according to DIN IEC 751.

In practice, a value multiplied by  $10^6$  is often entered:  $TCR = 10^6 \times \frac{R_{100} - R_0}{100 - R_0}$  x (ppm/K)

In this case, the numerical value is 3850 ppm/K.

## SPECIFICATIONS

### Temperature Characteristic Curve

The temperature characteristic curve determines the dependence of the electrical resistivity on the temperature. The following definition of the temperature curve according to DIN EN 60751 standard applies:

-200 to 0°C	$R(t) = R_0[1+(A*t)+(B*t^2)+C(t-100)t^3]$
0 to 250°C	$R(t) = R_0[1+(A*t)+(B*t^2)]$

Platinum (3850 ppm/K):

$A = 3.9083 \times 10^{-3} [^{\circ}\text{C}^{-1}]$

$B = -5.775 \times 10^{-7} [^{\circ}\text{C}^{-2}]$

$C = -4.183 \times 10^{-12} [^{\circ}\text{C}^{-4}]$

Platinum (3750 ppm/K):

$A = 3.9083 \times 10^{-3} [^{\circ}\text{C}^{-1}]$

$B = -6.01888 \times 10^{-7} [^{\circ}\text{C}^{-2}]$

$C = -6 \times 10^{-12} [^{\circ}\text{C}^{-4}]$

$R_0$  = Resistance value in ohm at 0°C

t = temperature in accordance with ITS 90

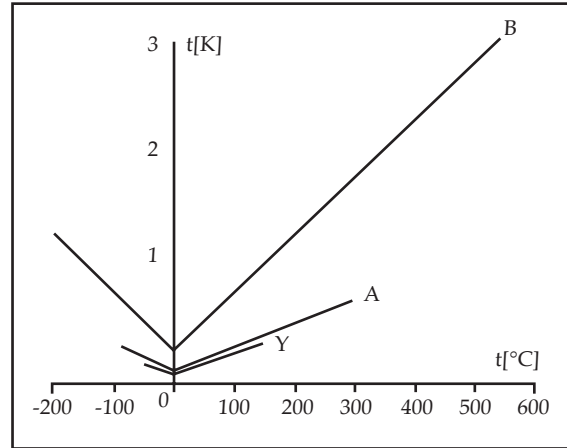

### Tolerance Classes

The temperature sensors are divided into classes according to their limit deviations:

Class	± limit deviations in °C (K)	IST AG designation	Temperature range
DIN 60751, class B	0.30 + 0.005 x  T	B	-200°C to 850°C
DIN 60751, class A	0.15 + 0.002 x  T	A	-90°C to 300°C
1/3 DIN 60751, class B	0.10 + 0.0017 x  T	Y	-50°C to 150°C

|T| is the numerical value of the temperature °C without taking into account either negative or positive signs.

Special selection of sensors upon request (pairings, groupings, special tolerances).

### Calibration Services

Durex RTD calibrations are fully traceable to the National Institute of Standards and Technology (NIST) and are useful for defining the exact temperature coefficient of the sensor. For sensor applications below 32°F (0°C), a cryogenic range calibration is recommended. Certificates are supplied with all calibrations. Printed tables of interpolated values are only supplied with cryogenic range calibrations.

### RTD Assembly Temperature Ranges

- Style: R1L, R2L, R3L, R4L  
The maximum rated temperature for these four styles is 500°F. Typically they are constructed with Teflon leads and the lead end is protected with an epoxy seal. This epoxy seal provides a moisture resistant barrier.
- Style: R1M, R2M, R3M, R4M  
The maximum rated temperature for these next four styles is 900°F. They are constructed with high temperature fiberglass insulated conductors. The lead end is sealed and protected with a high temperature cement.
- Style: R1P, R2P, R3P, R4P  
The maximum rated temperature for these last four styles is 1200°F. Their construction features highly compacted magnesium oxide insulation. Nickel conductors provide for extended temperature ratings and harsh environments.

# Resistance Temperature Detectors

## SPECIFICATIONS

### Available RTD Elements

Code	Element Type	Temperature Coefficient	Tolerance at 0°C
A	100 ohm Platinum	.00385	.1%
B	100 ohm Platinum	.00385	.06%
C	100 ohm Platinum	.00385	.03%
D	500 ohm Platinum	.00385	.1%
E	1000 ohm Platinum	.00385	.1%
F	2000 ohm Platinum	.00385	.1%
G	100 ohm Platinum	.00392	.1%
H	100 ohm Platinum	.00392	.03%
J	120 ohm Nickel	.00672	.5%
K	604 ohm Nickel Iron	.00520	.5%

### Wiring Diagrams

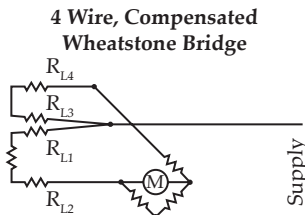
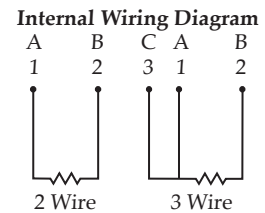
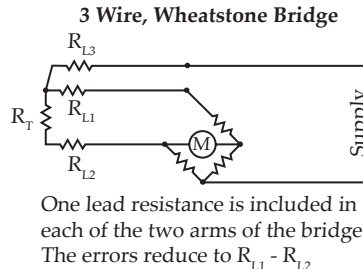
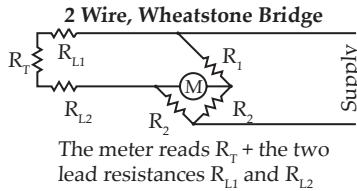

In this type  $R_{L3}$  and  $R_{L4}$  appear in one arm of the bridge.  $R_{L1}$  and  $R_{L2}$  appear in the other. Errors are  $R_{L1} + R_{L2} - R_{L3} - R_{L4}$

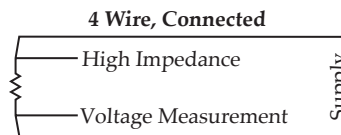

Errors can be made negligible by having a very high input impedance amplifier.

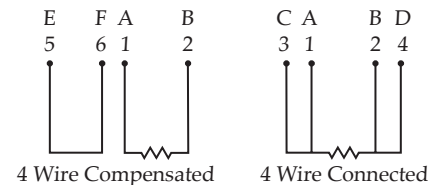

### Code Definitions

"L" Dimensions				"B" Dimensions				"A" Dimensions		Fractional Dimension Letter Code					
"L" dimensions are specified in whole inches and a single alpha character which represents a fraction. Enter the three digit code as follows:				"B" dimensions are specified in fractions from 1/8" to 1". Use the single alpha character to indicate the tip length. Enter the code as follows:				"A" dimensions are specified in whole inches only. Enter the three digit code as follows:		1/16"	A	11/16"	L	Fraction	
										3/8"	B	3/4"	M		
3/16"	C	13/16"	N												
1/4"	D	7/8"	P												
5/16"	E	15/16"	R												
3/8"	F	1"	S												
7/16"	G	0	No												
1/2"	H														
9/16"	J														
5/8"	K														
3"	030	10 5/8"	10K	1/8"	B	5/8"	K	9"	009	7/16"	G				
4 1/2"	04H	12"	120	1/4"	D	3/4"	M	12"	012	1/2"	H				
6 1/4"	06D	15 3/8"	15F	3/8"	F	7/8"	P	36"	036	9/16"	J				
7 7/8"	07P	17 3/4"	17M	1/2"	H	1"	S	144"	144	5/8"	K				

# Resistance Temperature Detectors

## RTD WITH LEADWIRE

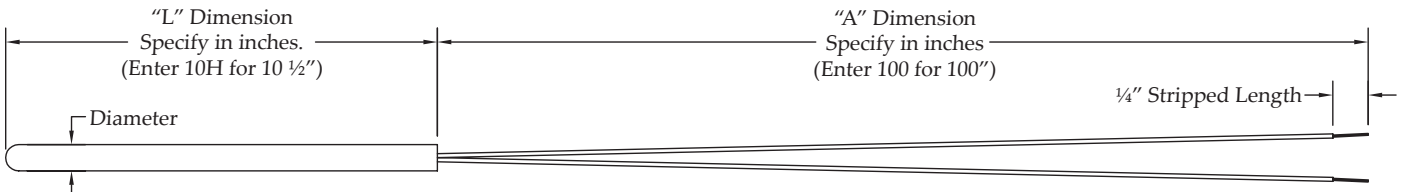

### STYLE R1L R1M

R1L - Maximum Temperature 500°F  
R1M - Maximum Temperature 900°F

Code	Table 1: Element Type
A	100 ohm .00385 Curve Class B Platinum
B	100 ohm .00385 Curve Class A Platinum
D	500 ohm .00385 Curve Class B Platinum
E	1000 ohm .00385 Curve Class B Platinum
G	100 ohm .00392 Curve Class B Platinum
J	120 ohm .00672 Curve Nickel (R1L Only)
K	604 ohm .00520 Curve Nickel Iron (R1L Only)

Code	Table 2: Wiring Configuration
A	Single, 2 Wire
B	Single, 3 Wire (Minimum sheath diameter .156")
C	Single, 4 Wire (Minimum sheath diameter .188")
D	Dual, 4 Wire (Minimum sheath diameter .188")
E	Dual, 6 Wire (Minimum sheath diameter .250")

Code	Table 3: Sheath Material
4	304 Stainless Steel
6	316 Stainless Steel
8	Inconel 600

Code	Table 4: Sheath Diameter
B	.125" or 1/8" O.D.
V	.156" or 5/32" O.D.
C	.188" or 3/16" O.D.
D	.250" or 1/4" O.D.
F	.375" or 3/8" O.D.

Code	Table 5: Sheath Length ("L" Dimension)
Specify in inches. See table on page 4 for codes.	

Code	Table 6: Lead Length ("A" Dimension)
Specify in inches. See table on page 4 for codes.	

Code	Table 7: Leadwire Type
A	Stranded Fiberglass Singles
B	Stranded Fiberglass with Overall Fiberglass Jacket
C	Stranded Fiberglass with Stainless Steel Overbraid
D	Stranded Fiberglass with Stainless Steel Armor
E	Stranded Mica/Fiberglass Singles
F	Stranded Teflon Singles (R1L Only)
G	Stranded Teflon with Overall Teflon Jacket (R1L Only)
J	Stranded Teflon with Stainless Steel Overbraid (R1L Only)
K	Stranded Teflon with Stainless Steel Armor (R1L Only)
M	PVC with Mylar Shield (R1L Only)

Code	Table 8: Terminations
0	2" Split Ends
1	#6 Spade Lug
2	BX Connector with #6 Spade Lug
3	Standard Plug
A	3/16" Quick Disconnect
B	3/16" Quick Disconnect, Insulated
C	1/4" Quick Disconnect
D	1/4" Quick Disconnect, Insulated
M	Mini Plug
X	Special, Specify

Code	Table 9: Fitting Options
0	No Fitting
N	1/8" NPT Compression, Brass
P	1/8" NPT Compression, Stainless Steel
R	1/4" NPT Compression, Brass
S	1/4" NPT Compression, Stainless Steel
V	1/2" NPT Compression, Stainless Steel
X	Special, Specify

### Part Number Sequence

R1L-AB-4F100-100FCR

R1L	-	A		B	-	4		F		100	-	100		F		C		R
R1L or R1M	Table 1	Table 2	Table 3	Table 4	Table 5	Table 6	Table 7	Table 8	Table 9									
Sensor Type & Style No.	Element Type	Wiring Configuration	Sheath Material	Sheath Diameter	"L" Sheath Length	"A" Lead Length	Leadwire Type	Terminations	Fitting Options									

# Resistance Temperature Detectors

## HIGH TEMPERATURE RTD WITH LEADWIRE

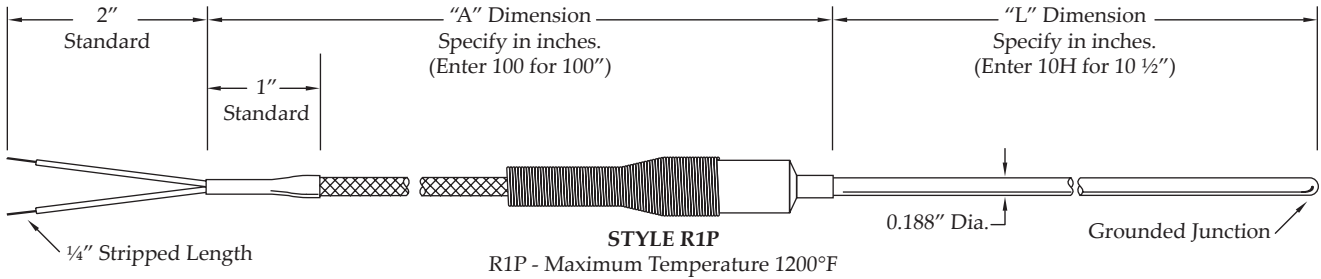

Code	Table 1: Element Type
A	100 ohm .00385 Curve Class B Platinum
B	100 ohm .00385 Curve Class A Platinum
D	500 ohm .00385 Curve Class B Platinum
E	1000 ohm .00385 Curve Class B Platinum
G	100 ohm .00392 Curve Class B Platinum

Code	Table 7: Leadwire Type
A	Stranded Fiberglass Singles
B	Stranded Fiberglass with Overall Fiberglass Jacket
C	Stranded Fiberglass with Stainless Steel Overbraid
D	Stranded Fiberglass with Stainless Steel Armor
E	Stranded Mica/Fiberglass Singles

Code	Table 2: Wiring Configuration
A	Single, 2 Wire
B	Single, 3 Wire (Minimum sheath diameter .156")
C	Single, 4 Wire (Minimum sheath diameter .188")
D	Dual, 4 Wire (Minimum sheath diameter .188")
E	Dual, 6 Wire (Minimum sheath diameter .250")

Code	Table 8: Terminations
0	2" Split Ends
1	#6 Spade Lug
2	BX Connector with #6 Spade Lug
3	Standard Plug
A	3/16" Quick Disconnect
B	3/16" Quick Disconnect, Insulated
C	1/4" Quick Disconnect
D	1/4" Quick Disconnect, Insulated
M	Mini Plug
X	Special, Specify

Code	Table 3: Sheath Material
4	304 Stainless Steel
6	316 Stainless Steel
8	Inconel 600

Code	Table 4: Sheath Diameter
B	.125" or 1/8" O.D.
V	.156" or 5/32" O.D.
C	.188" or 3/16" O.D.
D	.250" or 1/4" O.D.
F	.375" or 3/8" O.D.

Code	Table 5: Sheath Length ("L" Dimension)
	Specify in inches. See table on page 4 for codes.

Code	Table 9: Fitting Options
0	No Fitting
N	1/8" NPT Compression, Brass
P	1/8" NPT Compression, Stainless Steel
R	1/4" NPT Compression, Brass
S	1/4" NPT Compression, Stainless Steel
V	1/2" NPT Compression, Stainless Steel
X	Special, Specify

Code	Table 6: Lead Length ("A" Dimension)
	Specify in inches. See table on page 4 for codes.

### Part Number Sequence

R1P-AA-4B09H-072ECR

R1P	-	A		A	-	4		B		09H	-	072		E		C		R
R1P		Table 1		Table 2		Table 3		Table 4		Table 5		Table 6		Table 7		Table 8		Table 9
Sensor Type & Style No.		Element Type		Wiring Configuration		Sheath Material		Sheath Diameter		"L" Sheath Length		"A" Lead Length		Leadwire Type		Terminations		Fitting Options

# Resistance Temperature Detectors

## RTD WITH FIXED FITTING

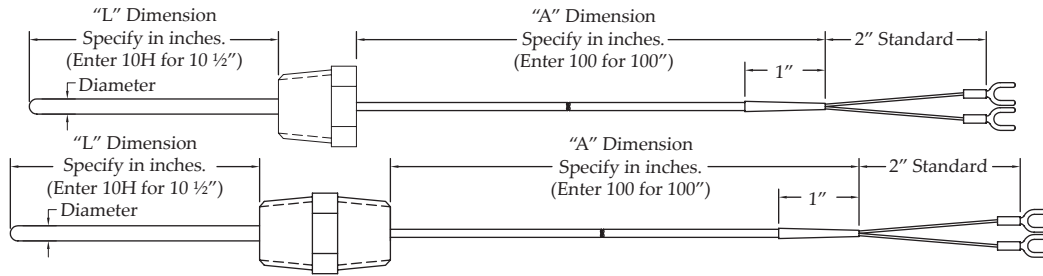

STYLE R2L, R2M or R2P

R2L - Maximum Temperature 500°F

R2M - Maximum Temperature 900°F

R2P - Maximum Temperature 1200°F

Code	Table 1: Element Type
A	100 ohm .00385 Curve Class B Platinum
B	100 ohm .00385 Curve Class A Platinum
D	500 ohm .00385 Curve Class B Platinum
E	1000 ohm .00385 Curve Class B Platinum
G	100 ohm .00392 Curve Class B Platinum
J	120 ohm .00672 Curve Nickel (R2L Only)
K	604 ohm .00520 Curve Nickel Iron (R2L Only)

Code	Table 2: Wiring Configuration
A	Single, 2 Wire
B	Single, 3 Wire (Minimum sheath diameter .156")
C	Single, 4 Wire (Minimum sheath diameter .188")
D	Dual, 4 Wire (Minimum sheath diameter .188")
E	Dual, 6 Wire (Minimum sheath diameter .250")

Code	Table 3: Sheath Material
4	304 Stainless Steel
6	316 Stainless Steel
8	Inconel 600

Code	Table 4: Sheath Diameter
B	.125" or 1/8" O.D.
V	.156" or 5/32" O.D.
C	.188" or 3/16" O.D.
D	.250" or 1/4" O.D.
F	.375" or 3/8" O.D.

Code	Table 5: Sheath Length ("L" Dimension)
	Specify in inches. See table on page 4 for codes.

Code	Table 6: Lead Length ("A" Dimension)
	Specify in inches. See table on page 4 for codes.

Code	Table 7: Leadwire Type
A	Stranded Fiberglass Singles
B	Stranded Fiberglass with Overall Fiberglass Jacket
C	Stranded Fiberglass with Stainless Steel Overbraid
D	Stranded Fiberglass with Stainless Steel Armor
E	Stranded Mica/Fiberglass Singles
F	Stranded Teflon Singles (R2L Only)
G	Stranded Teflon with Overall Teflon Jacket (R2L Only)
J	Stranded Teflon with Stainless Steel Overbraid (R2L Only)
K	Stranded Teflon with Stainless Steel Armor (R2L Only)
M	PVC with Mylar Shield (R2L Only)

Code	Table 8: Spring Loaded Options
1	Fixed Fitting
2	Spring Loaded Fitting

Code	Table 9: Terminations
0	2" Split Ends
1	#6 Spade Lug
2	BX Connector with #6 Spade Lug
3	Standard Plug
A	3/16" Quick Disconnect
B	3/16" Quick Disconnect, Insulated
C	1/4" Quick Disconnect
D	1/4" Quick Disconnect, Insulated
M	Mini Plug
X	Special, Specify

Code	Table 10: Fitting Options
1	1/4" NPT x 1/4" NPT Brass Hex Nipple
2	1/4" NPT x 1/4" NPT Stainless Steel Hex Nipple
5	1/2" NPT x 1/2" NPT Brass Hex Nipple
6	1/2" NPT x 1/2" NPT Stainless Steel Hex Nipple
C	1/4" NPT Brass Bushing
D	1/4" NPT Stainless Steel Bushing
G	1/2" NPT Brass Bushing
H	1/2" NPT Stainless Steel Bushing
X	Special, Specify

### Part Number Sequence R2P-EB-4V12F-018E1CC

R2P	-	E	B	-	4	V	12F	-	018	E	1	C	C
R2L, R2M, R2P		Table 1	Table 2		Table 3	Table 4	Table 5		Table 6	Table 7	Table 8	Table 9	Table 10
Sensor Type & Style No.		Element Type	Wiring Configuration		Sheath Material	Sheath Diameter	"L" Sheath Length		"A" Lead Length	Leadwire Type	Spring Loading	Terminations	Fitting Options

# Resistance Temperature Detectors

## RTD WITH PLUG

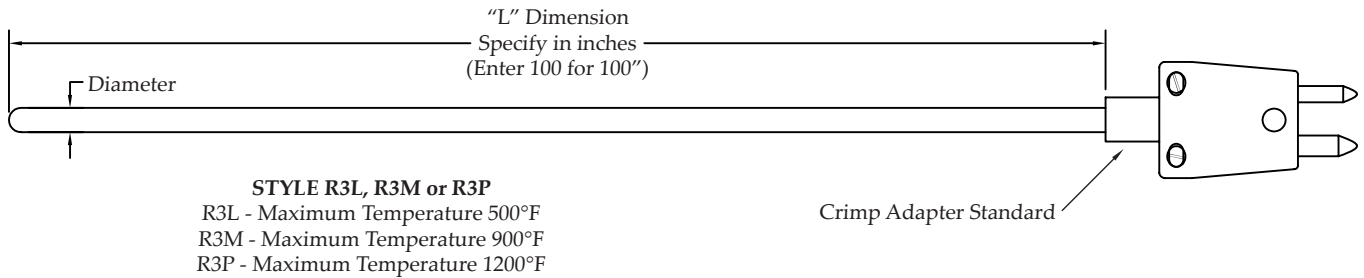

Code	Table 1: Element Type
A	100 ohm .00385 Curve Class B Platinum
B	100 ohm .00385 Curve Class A Platinum
D	500 ohm .00385 Curve Class B Platinum
E	1000 ohm .00385 Curve Class B Platinum
G	100 ohm .00392 Curve Class B Platinum
J	120 ohm .00672 Curve Nickel (R3L Only)
K	604 ohm .00520 Curve Nickel Iron (R3L Only)

Code	Table 4: Sheath Diameter
B	.125" or 1/8" O.D.
V	.156" or 5/32" O.D.
C	.188" or 3/16" O.D.
D	.250" or 1/4" O.D.
F	.375" or 3/8" O.D.

Code	Table 2: Wiring Configuration
A	Single, 2 Wire
B	Single, 3 Wire (Minimum sheath diameter .156")
C	Single, 4 Wire (Minimum sheath diameter .188")
D	Dual, 4 Wire (Minimum sheath diameter .188")
E	Dual, 6 Wire (Minimum sheath diameter .250")

Code	Table 5: Sheath Length ("L" Dimension)
Specify in inches. See table on page 4 for codes.	

Code	Table 3: Sheath Material
4	304 Stainless Steel
6	316 Stainless Steel
8	Inconel 600

Code	Table 6: Terminations
5	Standard Plug with Crimp Connector
7	Standard Plug with Tube Adapter
J	Open Disk Block, Ceramic
K	Open Disk Block, Glass Fiber
M	Mini Plug with Crimp Adapter
X	Special, Specify

### Part Number Sequence

R3L-BB-6F100-5

R3L - B B - 6 F 100 - 5

R3L, R3M, R3P	Table 1	Table 2	Table 3	Table 4	Table 5	Table 6
Sensor Type & Style No.	Element Type	Wiring Configuration	Sheath Material	Sheath Diameter	"L" Sheath Length	Terminations



# Resistance Temperature Detectors

## RTD WITH TERMINAL HEAD

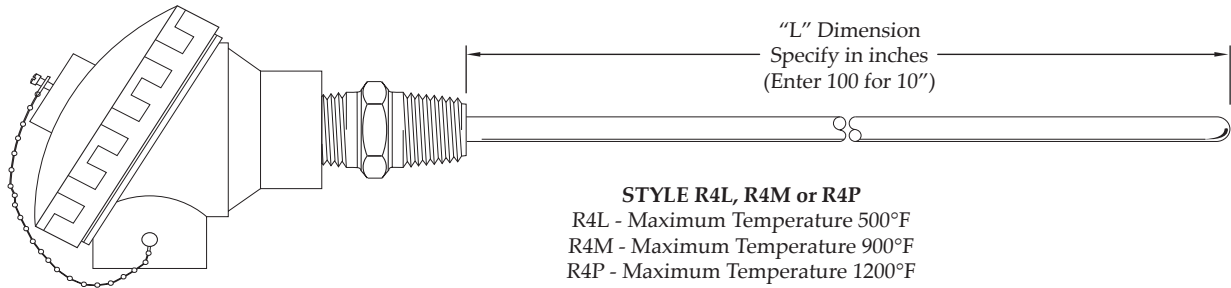

**STYLE R4L, R4M or R4P**  
 R4L - Maximum Temperature 500°F  
 R4M - Maximum Temperature 900°F  
 R4P - Maximum Temperature 1200°F

Code	Table 1: Element Type
A	100 ohm .00385 Curve Class B Platinum
B	100 ohm .00385 Curve Class A Platinum
D	500 ohm .00385 Curve Class B Platinum
E	1000 ohm .00385 Curve Class B Platinum
G	100 ohm .00392 Curve Class B Platinum
J	120 ohm .00672 Curve Nickel (R4L Only)
K	604 ohm .00520 Curve Nickel Iron (R4L Only)

Code	Table 6: Process Connections
6	½" NPT Stainless Steel Hex Nipple
8	¾" NPT Stainless Steel Hex Nipple

Code	Table 7: Spring Loaded Options
1	Fixed Fitting
2	Spring Loaded Fitting

Code	Table 2: Wiring Configuration
A	Single, 2 Wire
B	Single, 3 Wire (Minimum sheath diameter .156")
C	Single, 4 Wire (Minimum sheath diameter .188")
D	Dual, 4 Wire (Minimum sheath diameter .188")
E	Dual, 6 Wire (Minimum sheath diameter .250")

Code	Table 8: Terminal Heads
A	½" NPT Conduit, Aluminum Head
B	¾" NPT Conduit, Aluminum Head
C	½" NPT Conduit, Cast Iron Head
D	¾" NPT Conduit, Cast Iron Head
M	¼" NPT Conduit Connection, Miniature Plastic Head
P	½" NPT Conduit, Grey Delrin Head
R	¾" NPT Conduit, Grey Delrin Head
W	½" NPT Conduit, White Polypropylene Head
V	¾" NPT Conduit, White Polypropylene Head
Z	½" NPT Conduit, Explosion Proof Aluminum Head
Y	¾" NPT Conduit, Explosion Proof Aluminum Head

Code	Table 3: Sheath Material
4	304 Stainless Steel
6	316 Stainless Steel
8	Inconel 600

Code	Table 4: Sheath Diameter
B	.125" or ½" O.D.
V	.156" or 5/32" O.D.
C	.188" or 3/16" O.D.
D	.250" or ¼" O.D.
F	.375" or 3/8" O.D.

Code	Table 9: Fitting Options
0	No Fitting
N	⅛" NPT Compression, Brass
P	⅛" NPT Compression, Stainless Steel
R	¼" NPT Compression, Brass
S	¼" NPT Compression, Stainless Steel
V	½" NPT Compression, Stainless Steel
X	Special, Specify

Code	Table 5: Sheath Length ("L" Dimension)
Specify in inches. See table on page 4 for codes.	

### Part Number Sequence

R4L-EA-4C060-62AR

R4L - E A - 4 C 060 - 6 2 A R

R4L, R4M, R4P	Table 1	Table 2	Table 3	Table 4	Table 5	Table 6	Table 7	Table 8	Table 9
Sensor Type & Style No.	Element Type	Wiring Configuration	Sheath Material	Sheath Diameter	"L" Sheath Length	Process Connections	Spring Loading	Terminal Head	Fitting Options

# Resistance Temperature Detectors

## MELT BOLT RTD

Durex melt bolts are designed for dependable temperature measurement of the plastic melt stream within extruders and injection molding equipment. Standard assemblies are supplied with mineral insulated sensing elements for extended pressure and temperature performance. For options at the probe tip there are thermal barriers of Teflon (500°F) and Mycalex (900°F) available upon request.

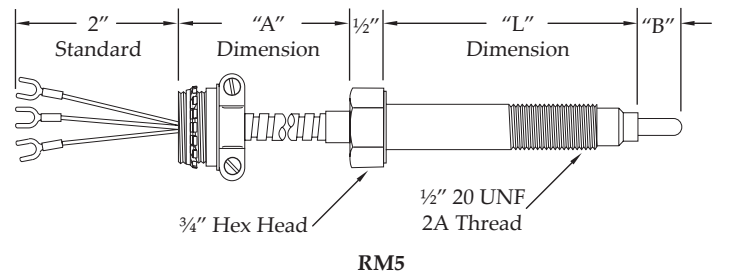
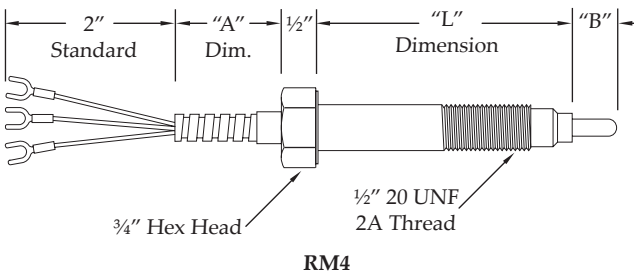
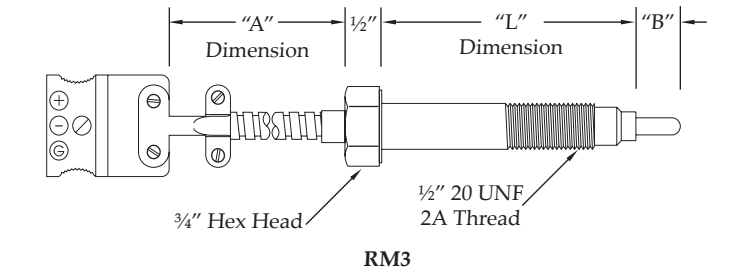
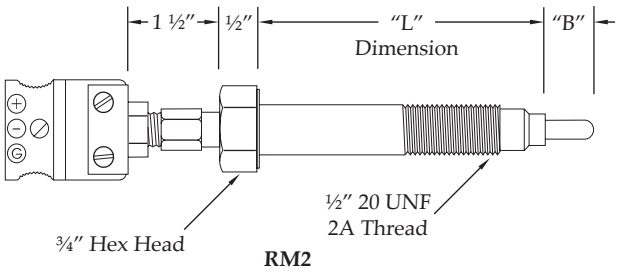
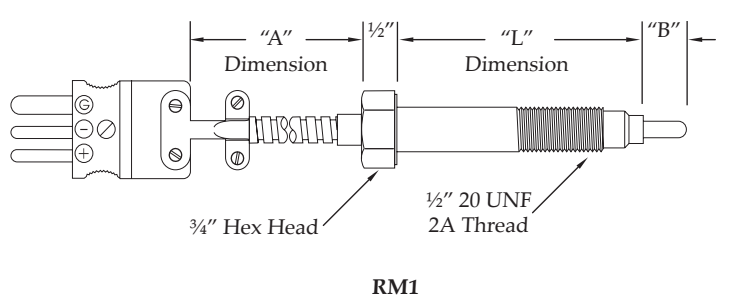
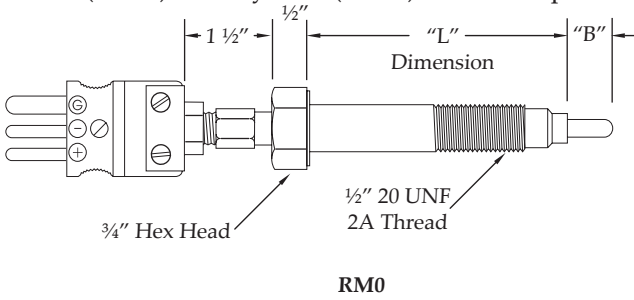

Code	Table 1: Element Type
A	100 ohm .00385 Curve Class B Platinum
B	100 ohm .00385 Curve Class A Platinum
D	500 ohm .00385 Curve Class B Platinum
E	1000 ohm .00385 Curve Class B Platinum
G	100 ohm .00392 Curve Class B Platinum

Code	Table 2: Wiring Configuration
A	Single, 2 Wire
B	Single, 3 Wire (Minimum sheath diameter .156")
C	Single, 4 Wire (Minimum sheath diameter .188")
D	Dual, 4 Wire (Minimum sheath diameter .188")
E	Dual, 6 Wire (Minimum sheath diameter .250")

### Part Number Sequence RM1-EA-030-S024L

RM1	-	E	A	-	030	-	S	024	L
RM0 - RM5		Table 1	Table 2		"L" Dim.		"B" Dim.	"A" Dim.	Operating Temp.
Sensor Type & Style No.		Element Type	Wiring Configuration		030 = 3" / 040 = 4" 060 = 6"		See Page 4	See Page 4	L = 500°F M = 900°F

### Blank Bolts

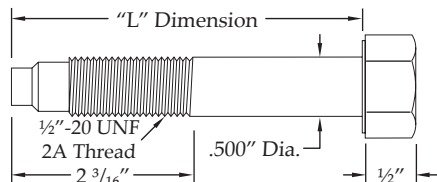

"L" Dimension	Part Number
3"	244008
4"	244053
6"	244009

Blank Bolts occupy hole when Melt Bolt is removed.

# Resistance Temperature Detectors

## SURFACE MOUNT RTDS

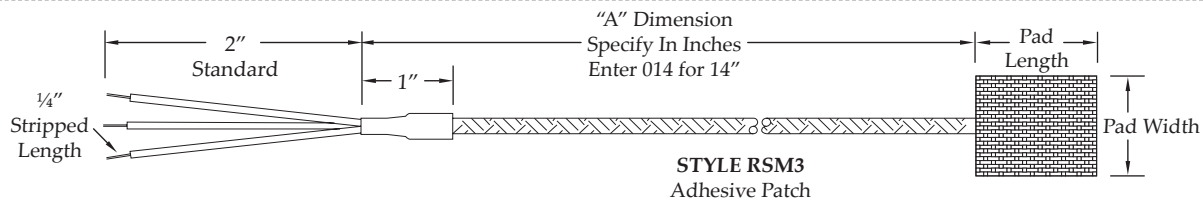
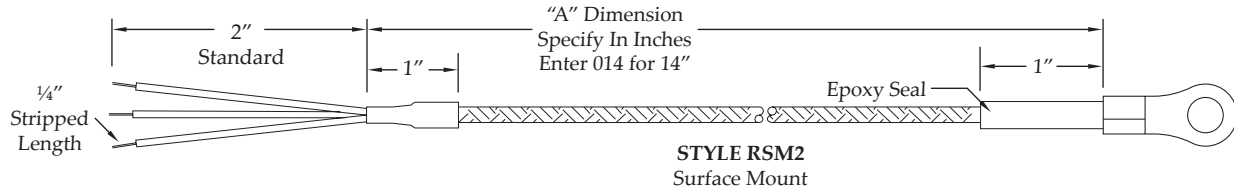
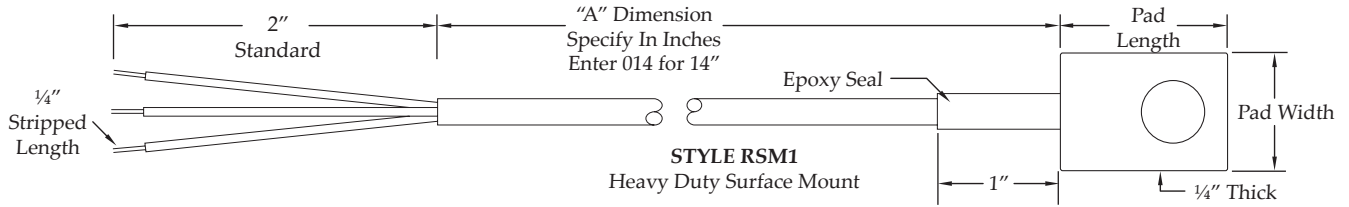

Code	Table 1: Element Type
A	100 ohm .00385 Curve Class B Platinum
B	100 ohm .00385 Curve Class A Platinum
D	500 ohm .00385 Curve Class B Platinum
E	1000 ohm .00385 Curve Class B Platinum
G	100 ohm .00392 Curve Class B Platinum

Code	Table 2: Wiring Configuration
A	Single, 2 Wire
B	Single, 3 Wire (Minimum sheath diameter .156")
C	Single, 4 Wire (Minimum sheath diameter .188")
D	Dual, 4 Wire (Minimum sheath diameter .188")
E	Dual, 6 Wire (Minimum sheath diameter .250")

Code	Table 3: Pad Material
B	Brass
F	Fiberglass
4	304 Stainless Steel
0	None

Code	Table 4: Pad Thickness
C	3/16" (.188")
D	1/4" (.250")
H	1/2" (.500")
0	None

Code	Table 5: Pad Width
06H	6.5" LG
00M	Standard (.750")
000	No Pad

Code	Table 6: Pad Length
06H	6.5" Long
010	Standard (1")
000	No Pad

Code	Table 7: Lead Length ("A" Dimension)
Specify in inches. See table on page 4 for codes.	

Code	Table 8: Leadwire Type
A	Stranded Fiberglass Singles
B	Stranded Fiberglass with Overall Fiberglass Jacket
E	Stranded Mica/Fiberglass
F	Stranded Teflon Singles
J	Stranded Teflon with Stainless Steel Overbraid
K	Stranded Teflon with Stainless Steel Armor
M	PVC with Mylar Shield

Code	Table 9: Terminations
0	2" Split Ends
1	#6 Spade Lug
2	BX Connector with #6 Spade Lug
3	Standard Plug
M	Mini Plug
X	Special, Specify

Code	Table 10: Mounting Hole
A	No. 6 Stud Size, .144" Hole Diameter
B	No. 6 Stud Size, .169" Hole Diameter
C	No. 10 Stud Size, .196" Hole Diameter
D	1/4" Stud Size, .266" Hole Diameter
E	3/8" Stud Size, .390" Hole Diameter
P	Patch

### Part Number Sequence RSM1-AB-BD00M010-060F3A

RSM1, RSM2, RSM3	Table 1	Table 2	Table 3	Table 4	Table 5	Table 6	Table 7	Table 8	Table 9	Table 10
Sensor Type & Style No.	Element Type	Wiring Configuration	Pad Material	Pad Thickness	Pad Width	Pad Length	Leadwire Length	Leadwire Type	Terminations	Mounting Hole
RSM1	A	B	B	D	00M	010	060	F	3	A

# Resistance Temperature Detectors

## RTD THERMOWELLS

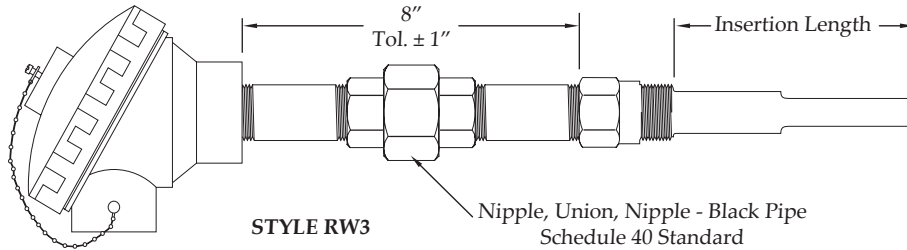
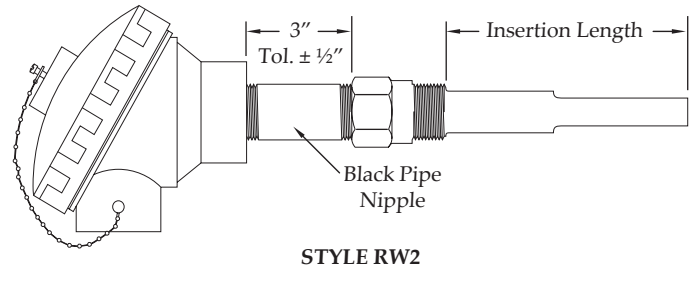
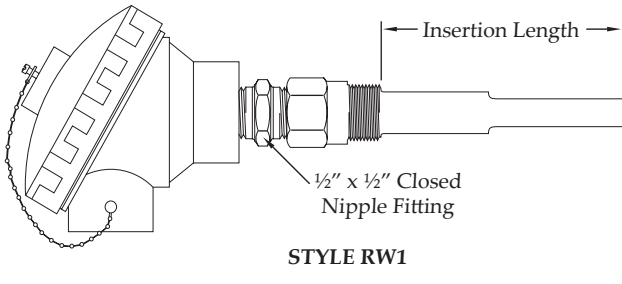

Code	Table 1: Element Type
A	100 ohm .00385 Curve Class B Platinum
B	100 ohm .00385 Curve Class A Platinum
D	500 ohm .00385 Curve Class B Platinum
E	1000 ohm .00385 Curve Class B Platinum
G	100 ohm .00392 Curve Class B Platinum
J	120 ohm .00672 Curve Nickel
K	604 ohm .00520 Curve Nickel Iron

Code	Table 5: Process Connection Material
K	Black Pipe, Schedule 40
Y	Galvanized Pipe, Schedule 40
4	304 Stainless Steel

Code	Table 2: Wiring Configuration
A	Single, 2 Wire
B	Single, 3 Wire (Minimum sheath diameter .156")
C	Single, 4 Wire (Minimum sheath diameter .188")
D	Dual, 4 Wire (Minimum sheath diameter .188")
E	Dual, 6 Wire (Minimum sheath diameter .250")

Code	Table 6: Spring Loaded Options
1	Fixed Fitting
2	Spring Loaded Fitting

Code	Table 3: Thermowell Number
See next page for Thermowell Code Numbers	

Code	Table 7: Terminal Heads
A	1/2" NPT Conduit, Aluminum Head
B	3/4" NPT Conduit, Aluminum Head
C	1/2" NPT Conduit, Cast Iron Head
D	3/4" NPT Conduit, Cast Iron Head
M	1/4" NPT Conduit Connection, Miniature Plastic Head
P	1/2" NPT Conduit, Grey Delrin Head
R	3/4" NPT Conduit, Grey Delrin Head
W	1/2" NPT Conduit, White Polypropylene Head
V	3/4" NPT Conduit, White Polypropylene Head
Z	1/2" NPT Conduit, Explosion Proof Aluminum Head
Y	3/4" NPT Conduit, Explosion Proof Aluminum Head

Code	Table 4: Well Material
4	304 Stainless Steel
6	316 Stainless Steel

### Part Number Sequence RW3-AB-5302H4-K2D

RW3	-	A	B	-	5302H	4	-	K	2	D
RW1, RW2, RW3		Table 1	Table 2		Table 3	Table 4		Table 5	Table 6	Table 7
Sensor Type & Style No.		Element Type	Wiring Configuration		Thermowell Number	Well Material		Process Connection Material	Spring Loading	Terminal Head

# Resistance Temperature Detectors

## RTD THERMOWELLS

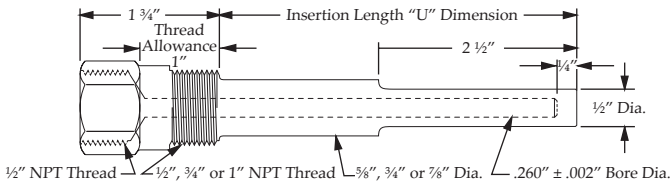

Standard Well - Stepped Shank

"U" Dim.	1/2" NPT	3/4" NPT	1" NPT
2 1/2"	1202H	1302H	1402H
4 1/2"	1204H	1304H	1404H
6"	12060	13060	14060
7 1/2"	1207H	1307H	1407H
10 1/2"	1210H	1310H	1410H
12"	12120	13120	14120
16 1/2"	1216H	1316H	1416H
22 1/2"	1222H	1322H	1422H

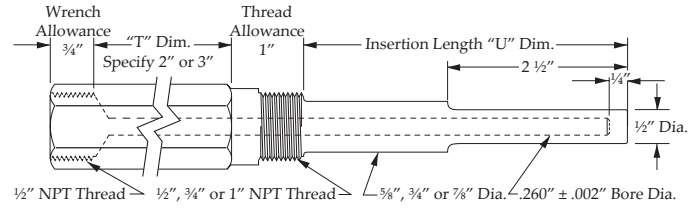

Lagging Extension Well - Stepped Shank

"U" Dim.	1/2" NPT	3/4" NPT	1" NPT
2 1/2"	2202H	2302H	2402H
4 1/2"	2204H	2304H	2404H
6"	22060	23060	24060
7 1/2"	2207H	2307H	2407H
10 1/2"	2210H	2310H	2410H
12"	22120	23120	24120
16 1/2"	2216H	2316H	2416H
22 1/2"	2222H	2322H	2422H

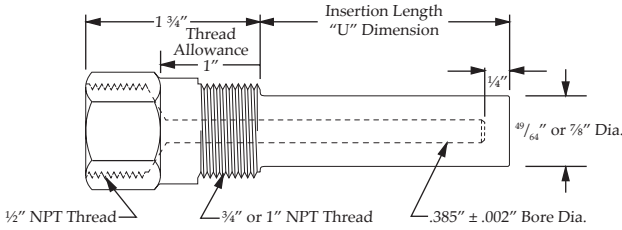

Standard Well - Straight Shank

"U" Dim.	3/4" NPT	1" NPT
2 1/2"	3302H	3402H
4 1/2"	3304H	3404H
6"	33060	34060
7 1/2"	3307H	3407H
10 1/2"	3310H	3410H
12"	33120	34120
16 1/2"	3316H	3416H
22 1/2"	3322H	3422H

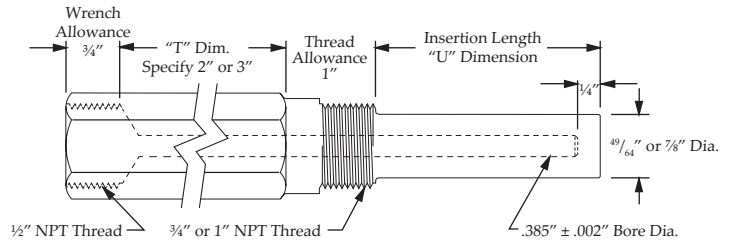

Lagging Extension Well - Straight Shank

"U" Dim.	3/4" NPT	1" NPT
2 1/2"	4302H	4402H
4 1/2"	4304H	4404H
6"	43060	44060
7 1/2"	4307H	4407H
10 1/2"	4310H	4410H
12"	43120	44120
16 1/2"	4316H	4416H
22 1/2"	4322H	4422H

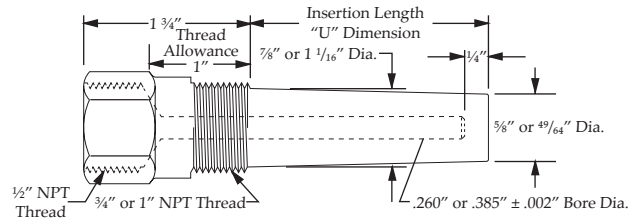

Standard Well - Tapered Shank

"U" Dim.	3/4" NPT		1" NPT	
	.260" Bore	.385" Bore	.260" Bore	.385" Bore
2 1/2"	5302H	6302H	5402H	6402H
4 1/2"	5304H	6304H	5404H	6404H
6"	53060	63060	54060	64060
7 1/2"	5307H	6307H	5407H	6407H
10 1/2"	5310H	6310H	5410H	6410H
12"	53120	63120	54120	64120
16 1/2"	5316H	6316H	5416H	6416H
22 1/2"	5322H	6322H	5422H	6422H

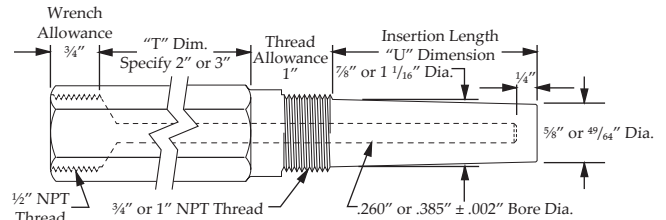

Lagging Extension Well - Tapered Shank

"U" Dim.	3/4" NPT		1" NPT	
	.260" Bore	.385" Bore	.260" Bore	.385" Bore
2 1/2"	7302H	8302H	7402H	8402H
4 1/2"	7304H	8304H	7404H	8404H
6"	73060	83060	74060	84060
7 1/2"	7307H	8307H	7407H	8407H
10 1/2"	7310H	8310H	7410H	8410H
12"	73120	83120	74120	84120
16 1/2"	7316H	8316H	7416H	8416H
22 1/2"	7322H	8322H	7422H	8422H

# Resistance Temperature Detectors

## HAND HELD RTDS

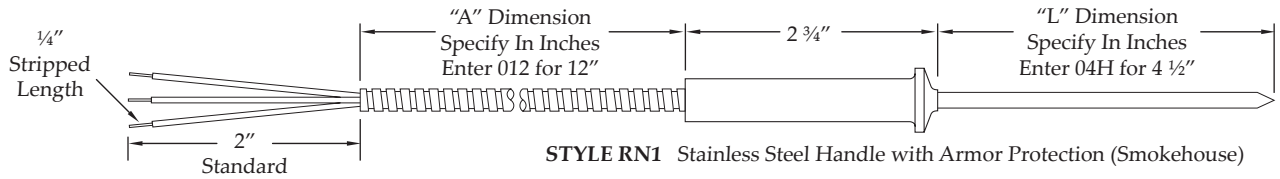

STYLE RN1 Stainless Steel Handle with Armor Protection (Smokehouse)

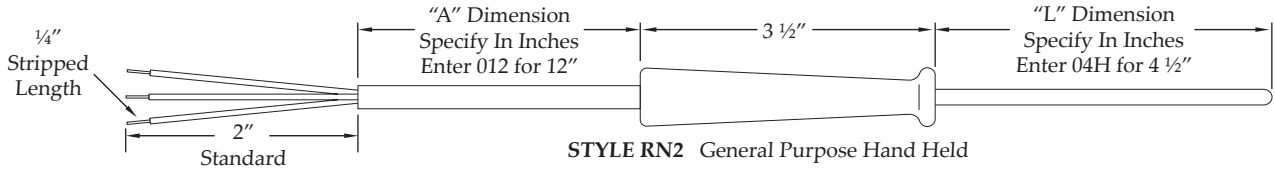

STYLE RN2 General Purpose Hand Held

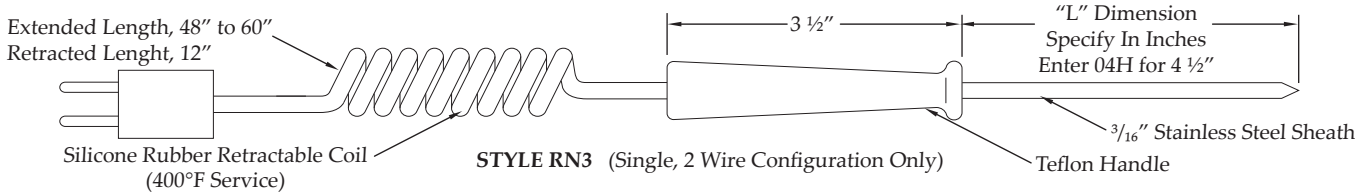

STYLE RN3 (Single, 2 Wire Configuration Only)

Code	Table 1: Element Type
A	100 ohm .00385 Curve Class B Platinum
B	100 ohm .00385 Curve Class A Platinum
D	500 ohm .00385 Curve Class B Platinum
E	1000 ohm .00385 Curve Class B Platinum
G	100 ohm .00392 Curve Class B Platinum
J	120 ohm .00672 Curve Nickel
K	604 ohm .00520 Curve Nickel Iron

Code	Table 6: Leadwire Type
C	Fiberglass Leadwire with Stainless Steel Overbraid
J	Teflon Leadwire with Stainless Steel Overbraid
K	Teflon Leadwire with Stainless Steel Armor
M	PVC Leadwire with Mylar Shield
R	Coiled PVC Cord (Single 2 Wire Only)
S	Coiled Silicone Rubber Cord (Single 2 Wire Only)

Code	Table 2: Wiring Configuration
A	Single, 2 Wire
B	Single, 3 Wire (Minimum sheath diameter .156")
C	Single, 4 Wire (Minimum sheath diameter .188")
D	Dual, 4 Wire (Minimum sheath diameter .188")
E	Dual, 6 Wire (Minimum sheath diameter .250")

Code	Table 7: Tip Configuration
R	Round
P	Piercing
A	Air Temperature
S	Surface

Code	Table 3: Sheath Diameter
B	.125" or 1/8" O.D.
V	.156" or 5/32" O.D.
C	.188" or 3/16" O.D.
D	.250" or 1/4" O.D.

Code	Table 8: Terminations
0	2" Split Ends
1	#6 Spade Lug
2	BX Connector with #6 Spade Lug
3	Standard Plug
A	3/16" Quick Disconnect
B	3/16" Quick Disconnect, Insulated
C	1/4" Quick Disconnect
D	1/4" Quick Disconnect, Insulated
M	Mini Plug
X	Special, Specify

Code	Table 4: Sheath Length ("L" Dimension)
	Specify in inches. See table on page 4 for codes.

Code	Table 5: Lead Length ("A" Dimension)
	Specify in inches. See table on page 4 for codes.

### Part Number Sequence RN2-AB-C04P-036MRD

RN2	-	A	B	-	C	04P	-	036	M	R	D
RN1, RN2, RN3		Table 1	Table 2		Table 3	Table 4		Table 5	Table 6	Table 7	Table 8
Sensor Type & Style No.		Element Type	Wiring Configuration		Sheath Diameter	"L" Sheath Length		"A" Lead Length	Leadwire Type	Tip Configuration	Terminations

# Resistance Temperature Detectors

## RTD WITH SANITARY FITTING

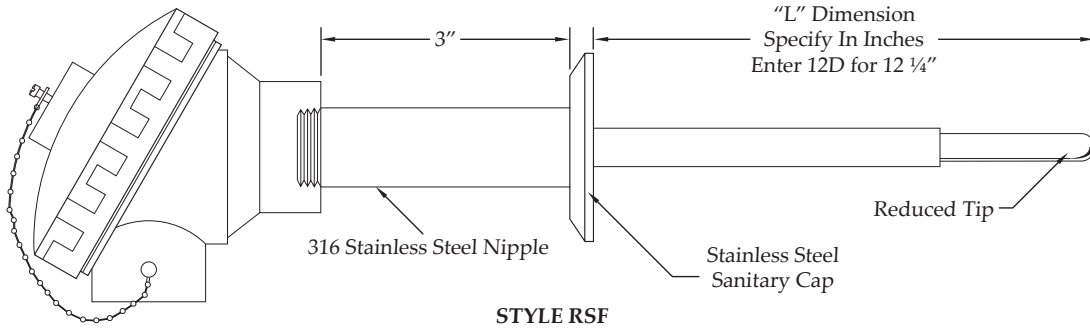

Code	Table 1: Element Type
A	100 ohm Platinum, Class B .00385 Coefficient
B	100 ohm Platinum, Class A .00385 Coefficient
E	1000 ohm Platinum, Class B .00385 Coefficient
G	100 ohm Platinum, Class B .00392 Coefficient

Code	Table 6: Sanitary Cap Type
T	16A Plain Cap, Tri Clover
U	16A Plain Cap & 13H Hex Union Nut, Tri Clover
X	Special, Specify

Code	Table 2: Wiring Configuration
A	Single, 2 Wire
B	Single, 3 Wire (Minimum sheath diameter .156")
C	Single, 4 Wire (Minimum sheath diameter .188")
D	Dual, 4 Wire (Minimum sheath diameter .188")
E	Dual, 6 Wire (Minimum sheath diameter .250")

Code	Table 7: Sanitary Cap Size
1	1 1/2" (Tube Outer Diameter)
2	2" (Tube Outer Diameter)
3	2 1/2" (Tube Outer Diameter)
4	3" (Tube Outer Diameter)
X	Special, Specify

Code	Table 3: Sheath Material
6	316 Stainless Steel

Code	Table 4: Sheath Diameter
C	.188" or 3/16" O.D.
D	.250" or 1/4" O.D.

Code	Table 8: Terminal Head
A	Aluminum Screw Cover Head; 1/2" NPT Conduit Connection
W	White Polypropylene FDA Compliant Screw Cover Head; 1/2" NPT Conduit Connection

Code	Table 5: Immersion Length ("L" Dimension)
	Specify in inches. See table on page 4 for codes.

### Part Number Sequence

RSF-HB-6D12D-T1W

RSF	-	H	B	-	6	D	12D	-	T	1	W
RSF		Table 1	Table 2		Table 3	Table 4	Table 5		Table 6	Table 7	Table 8
Sensor Type & Style No.		Element Type	Wiring Configuration		Sheath Material	Sheath Diameter	Immersion Length "L"		Cap Type	Cap Size	Terminal Head

# Resistance Temperature Detectors

## RTD WITH SANITARY WELLS CONNECTED

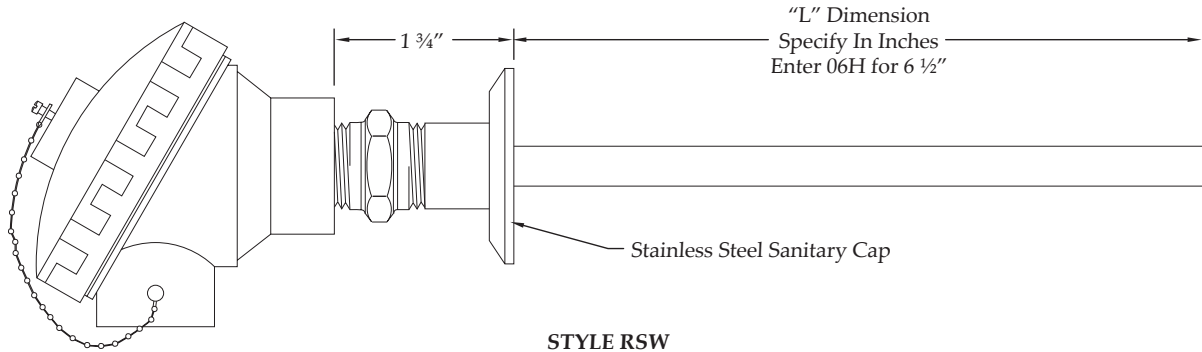

Code	Table 1: Element Type
A	100 ohm Platinum, Class B .00385 Coefficient
B	100 ohm Platinum, Class A .00385 Coefficient
E	1000 ohm Platinum, Class B .00385 Coefficient
G	100 ohm Platinum, Class B .00392 Coefficient

Code	Table 6: Sanitary Cap Type
T	16A Plain Cap, Tri Clover
U	16A Plain Cap & 13H Hex Union Nut, Tri Clover
X	Special, Specify

Code	Table 2: Wiring Configuration
A	Single, 2 Wire
B	Single, 3 Wire (Minimum sheath diameter .156")
C	Single, 4 Wire (Minimum sheath diameter .188")
D	Dual, 4 Wire (Minimum sheath diameter .188")
E	Dual, 6 Wire (Minimum sheath diameter .250")

Code	Table 7: Sanitary Cap Size
1	1 1/2" (Tube Outer Diameter)
2	2" (Tube Outer Diameter)
3	2 1/2" (Tube Outer Diameter)
4	3" (Tube Outer Diameter)
X	Special, Specify

Code	Table 3: Sheath Material
6	316 Stainless Steel

Code	Table 4: Sheath Diameter
H	.500 or 1/2" Outer Diameter

Code	Table 8: Terminal Head
A	Aluminum Screw Cover Head; 1/2" NPT Conduit Connection
W	White Polypropylene FDA Compliant Screw Cover Head; 1/2" NPT Conduit Connection

Code	Table 5: Immersion Length ("L" Dimension)
	Specify in inches. See table on page 4 for codes.

### Part Number Sequence

RSW-ED-6H06H-T1W

RSW	-	E	D	-	6	H	06H	-	T	1	W
RSW		Table 1	Table 2		Table 3	Table 4	Table 5		Table 6	Table 7	Table 8
Sensor Type & Style No.		Element Type	Wiring Configuration		Sheath Material	Sheath Diameter	Immersion Length "L"		Cap Type	Cap Size	Terminal Head



# Resistance Temperature Detectors

## TEFLON SHIELDED RTD

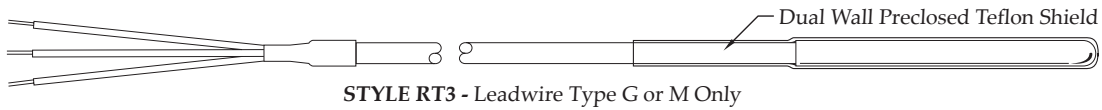
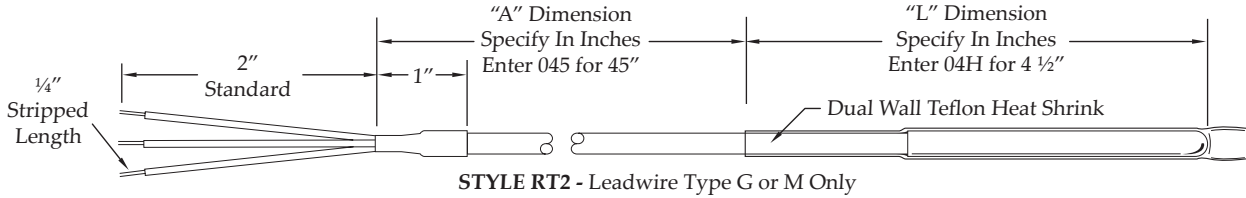
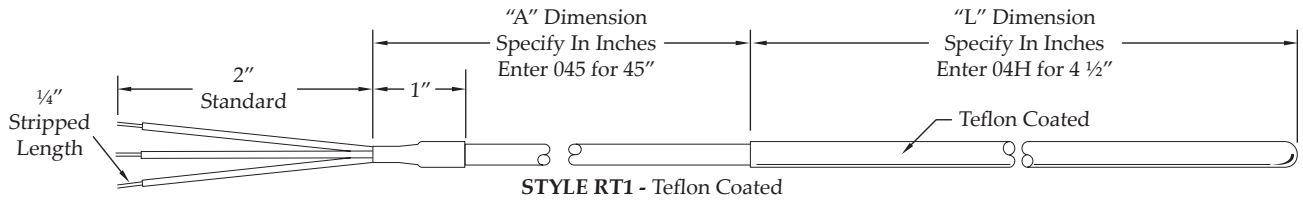

Code	Table 1: Element Type
A	100 ohm Platinum, Class B .00385 Coefficient
B	100 ohm Platinum, Class A .00385 Coefficient
E	1000 ohm Platinum, Class B .00385 Coefficient
G	100 ohm Platinum, Class B .00392 Coefficient

Code	Table 2: Wiring Configuration
A	Single, 2 Wire
B	Single, 3 Wire
C	Single, 4 Wire
D	Dual, 4 Wire
E	Dual, 6 Wire (Minimum sheath diameter .250")

Code	Table 3: Sheath Material
4	304 Stainless Steel
6	316 Stainless Steel

Code	Table 4: Sheath Diameter		
	Nominal	RT1	RT2 / RT3
C	.188"	.200"	.220"
D	.250"	.262"	.285"

Code	Table 5: Sanitary Length ("L" Dimension)
	Specify in inches. See table on page 4 for codes.

Code	Table 6: Lead Length ("A" Dimension)
	Specify in inches. See table on page 4 for codes.

Code	Table 7: Leadwire Type
A	Stranded Fiberglass Singles
B	Stranded Fiberglass with Overall Fiberglass Jacket
C	Stranded Fiberglass with Stainless Steel Overbraid
D	Stranded Fiberglass with Stainless Steel Armor
E	Stranded Mica/Fiberglass Singles
F	Stranded Teflon Singles
G	Stranded Teflon with Overall Teflon Jacket
J	Stranded Teflon with Stainless Steel Overbraid
K	Stranded Teflon with Stainless Steel Armor
M	PVC with Mylar Shield

Code	Table 8: Terminations
0	2" Split Ends
1	#6 Spade Lug
2	BX Connector with #6 Spade Lug
3	Standard Plug
A	3/16" Quick Disconnect
B	3/16" Quick Disconnect, Insulated
C	1/4" Quick Disconnect
D	1/4" Quick Disconnect, Insulated
M	Mini Plug
X	Special, Specify

### Part Number Sequence

RT2-AB-4C04H-024FC

RT1, RT2 or RT3	Table 1	Table 2	Table 3	Table 4	Table 5	Table 6	Table 7	Table 8
Sensor Type & Style No.	Element Type	Wiring Configuration	Sheath Material	Sheath Diameter	"L" Sheath Length	"A" Lead Length	Leadwire Type	Terminations

# Resistance Temperature Detectors

## INTEGRATED TRANSMITTER RTD ASSEMBLY

The unique line of Integrated Transmitter RTD Assemblies combines an industry standard 4-20mA transmitter with a matched high accuracy RTD (Resistive Temperature Device) in a compact, hermetically sealed assembly. The robust construction of this product enables it to withstand vibrations, harsh wash downs and drastic temperature changes in the roughest environmental conditions. This unique design eliminates the need for additional connection leads and hardware such as mounting boxes, transmitter housings, and cable tracks. Customer specified temperature range for the transmitter calibration as well as custom probe dimensions, extension cable length and type, and process connection types make these sensors a sure fit for the most challenging applications.

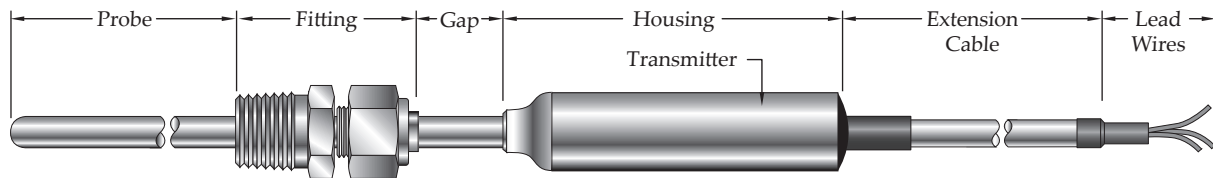

### Design Features:

- Can be recalibrated and re-scaled in the field.
- Compact size permits easy usage where space is limited
- Standard 2.5" long by 0.62" diameter housing holds electronic circuit and microprocessor
- Robust construction of transmitter housing resists wear in severe operating conditions
- Hermetic seal prevents moisture from entering the transmitter housing, ensuring reliability
- Sturdy construction is resistant to vibrations
- Cost effective and maintenance free

### Typical Applications:

- Generators
- Engines
- Compressors
- Pharmaceutical Industries
- Utilities
- Chemical Plants
- Gas Pipelines
- Food Preparation
- Refineries
- Petrochemical Plants
- Paper Mills

# Resistance Temperature Detectors

## INTEGRATED TRANSMITTER RTD ASSEMBLY

The IT22 assembly's configuration range stands out amongst other temperature sensors in its class. With a wide variety of probe diameters, temperature ranges, and fitting configurations, the IT22 can be designed to fit an abundance of applications.

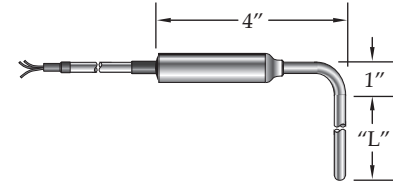
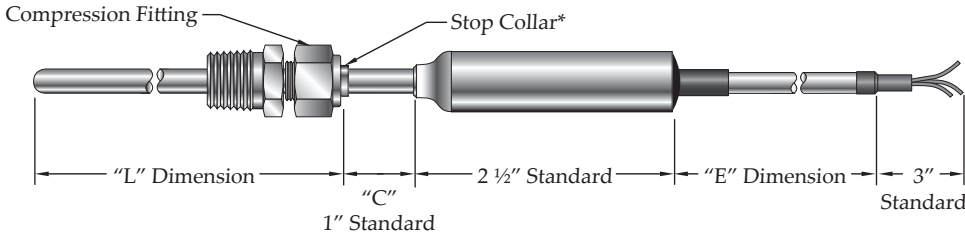

To order the IT22 with a 90° bend, add suffix "B" after the model number.  
Ex: IT22B

### STYLE IT22

\*No stop collar option, "C" = N00

Stop collar recommended for temperatures above 100°C

Code	Table 1: Calibrated Temperature Range
05	0 to 50°C (32-122°F)
10	0 to 100°C (32-212°F)
15	0 to 150°C (32-302°F)
20	0 to 200°C (32-392°F)
55	-50 to 50°C (-58-122°F)
51	-50 to 150°C (-58-302°F)
52	-50 to 200°C (-58-392°F)
XX	Custom Temperature Range, Specify

Integrated Transmitter RTD Assemblies are factory calibrated to an accuracy of ± 0.25% of span or better.

Code	Table 2: Output
LP	4-20 mA loop, upscale burnout (standard)
LD	4-20 mA loop, downscale burnout

Code	Table 3: Probe Diameter "D"
B	1/8"
C	3/16"
D	1/4"
F	3/8"
H	1/2"

Code	Table 4: Probe Material
S	316 Stainless Steel

Code	Table 5: Probe Length "L"
---	Specify in 0.1 inch increments. Ex: 065 = 6.5"

Code	Table 6: Extension Length "C"
N_ _	Specify in 0.1 inch increments. Ex: N20 = 2.0"

Code	Table 7: Fitting Type
N	None
S18S*	Compression Fitting (See below to configure)
*S18S is an example, configure fitting type:	
<b>Ferrule material:</b> S = Stainless Steel* B = Brass* T = Teflon *Not readjustable with metal ferrule	
<b>Process NPT Size:</b> 18 = 1/8" 14 = 1/4" 38 = 3/8" 12 = 1/2" 34 = 3/4" 44 = 1"	
<b>Fitting material:</b> S = Stainless Steel B = Brass	

Code	Table 8: Extension Cable Type
PV	PVC Insulation, 90°C (195°F) max.
TF	Teflon Insulation, 200°C (392°F) max.
TA	Teflon with Stainless Steel Armor, 200°C (392°F) max.
TB	Teflon with Stainless Steel Overbraid, 200°C (392°F) max.

Code	Table 9: Extension Cable Length "E"
---	Specify in inches. Ex: 060 = 60"

### Part Number Sequence IT22-05-LP-B-S-065-N20-N-TA-060

IT22	-	05	-	LP	-	B	-	S	-	065	-	N20	-	N	-	TA	-	060
IT22		Table 1		Table 2		Table 3		Table 4		Table 5		Table 6		Table 7		Table 8		Table 9
Sensor Type & Style No.		Temp Range		Output		Probe Diameter		Probe Material		Probe Length		Extension Length		Fitting Type		Extension Cable Type		Extension Cable Length

# Resistance Temperature Detectors

## INDUSTRIAL TEMPERATURE SENSOR WITH M12 MICRO-CONNECTOR

IT25 assemblies can be utilized in similar applications as the IT22, but the IT25 allows for quick disconnections. IT25 devices are effective in laboratory test equipment, hydraulic power units, skids, generators, and mobile equipment.

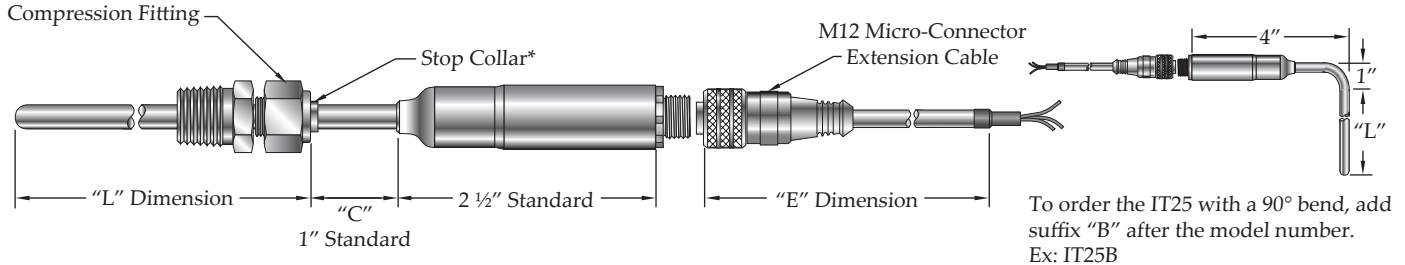

STYLE IT25

\*No stop collar option, "C" = N00

Stop collar recommended for temperatures above 100°C

To order the IT25 with a 90° bend, add suffix "B" after the model number.  
Ex: IT25B

Code	Table 1: Calibrated Temperature Range
05	0 to 50°C (32-122°F)
10	0 to 100°C (32-212°F)
15	0 to 150°C (32-302°F)
20	0 to 200°C (32-392°F)
55	-50 to 50°C (-58-122°F)
51	-50 to 150°C (-58-302°F)
52	-50 to 200°C (-58-392°F)
XX	Custom Temperature Range, Specify

Integrated Transmitter RTD Assemblies are factory calibrated to an accuracy of ± 0.25% of span or better.

Code	Table 2: Output
LP	4-20 mA loop, upscale burnout (standard)
LD	4-20 mA loop, downscale burnout

Code	Table 3: Probe Diameter "D"
B	1/8"
C	3/16"
D	1/4"
F	3/8"
H	1/2"

Code	Table 4: Probe Material
S	316 Stainless Steel

Code	Table 5: Probe Length "L"
---	Specify in 0.1 inch increments. Ex: 065 = 6.5"

Code	Table 6: Extension Length "C"
N_	Specify in 0.1 inch increments. Ex: N20 = 2.0"

Code	Table 7: Fitting Type
N	None
S18S*	Compression Fitting (See below to configure)

\*S18S is an example, configure fitting type:

**Ferrule material:**

S = Stainless Steel\* B = Brass\* T = Teflon

\*Not readjustable with metal ferrule

**Process NPT Size:**

18 = 1/8" 14 = 1/4"

38 = 3/8" 12 = 1/2"

34 = 3/4" 44 = 1"

**Fitting material:**

S = Stainless Steel B = Brass

Code	Table 8: Connector Type
M12	M12 Micro-Connector 5 pin male receptacle, Nickel Plated Brass

Code	Table 9: Extension Cable "E"
N	None
A2	Straight, 2 meters
A5	Straight, 5 meters
B2	Right Angle, 2 meters
B5	Right Angle, 5 meters

**Part Number Sequence** IT25-05-LP-B-S-065-N20-N-M12-A2

IT25	-	05	-	LP	-	B	-	S	-	065	-	N20	-	N	-	M12	-	A2
IT25		Table 1		Table 2		Table 3		Table 4		Table 5		Table 6		Table 7		Table 8		Table 9
Sensor Type & Style No.		Temp Range		Output		Probe Diameter		Probe Material		Probe Length		Extension Length		Fitting Type		Connector Type		Extension Cable

# Resistance Temperature Detectors

## SANITARY TEMPERATURE SENSOR WITH EXTENSION CABLE

ITS22 assemblies are particularly useful where extreme operating conditions exist in wash down situations and very wet environments. While external cables will withstand wash downs, to further protect the sensor and ensure longer life, stainless steel armor or overbraid can be custom added to prevent abrasion wear.

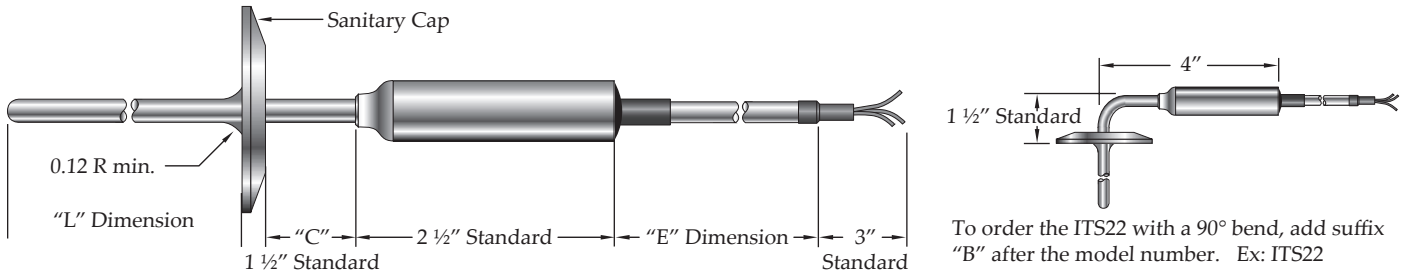

STYLE ITS22

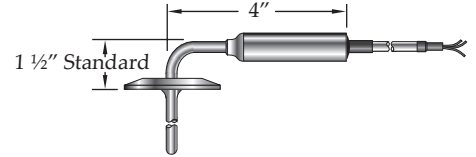

To order the ITS22 with a 90° bend, add suffix "B" after the model number. Ex: ITS22

Code	Table 1: Calibrated Temperature Range
05	0 to 50°C (32-122°F)
10	0 to 100°C (32-212°F)
15	0 to 150°C (32-302°F)
20	0 to 200°C (32-392°F)
55	-50 to 50°C (-58-122°F)
51	-50 to 150°C (-58-302°F)
52	-50 to 200°C (-58-392°F)
XX	Custom Temperature Range, Specify

Integrated Transmitter RTD Assemblies are factory calibrated to an accuracy of ± 0.25% of span or better.

Code	Table 2: Output
LP	4-20 mA loop, upscale burnout (standard)
LD	4-20 mA loop, downscale burnout

Code	Table 3: Probe Diameter "D"	
D	1/4"	
F	3/8"	
H	1/2"	
-	Sheath Outer Dia.	Tip Outer Dia.
DB	1/4"	1/8"
FC	3/8"	3/16"
HC	1/2"	3/16"
HD	1/2"	1/4"
JD	5/8"	1/4"

Code	Table 4: Probe Material
S	316 Stainless Steel

Code	Table 5: Probe Length "L"
---	Specify in 0.1 inch increments. Ex: 065 = 6.5"

Code	Table 6: Extension Length "C"
N_	Specify in 0.1 inch increments. Ex: N20 = 2.0"

Code	Table 7: Fitting Type
T15	Tri-Clamp, 1 1/2" (16 AMP)
T20	Tri-Clamp, 2" (16 AMP)
T25	Tri-Clamp, 2 1/2" (16 AMP)
T30	Tri-Clamp, 3" (16 AMP)

Code	Table 8: Extension Cable Type
PV	PVC Insulation, 90°C (195°F) max.
TF	Teflon Insulation, 200°C (392°F) max.
TA	Teflon with Stainless Steel Armor, 200°C (392°F) max.
TB	Teflon with Stainless Steel Overbraid, 200°C (392°F) max.

Code	Table 9: Extension Cable Length "E"
---	Specify in inches. Ex: 060 = 60"

Code	Table 10: Surface Finish
S	Standard
P	Pharmaceutical

### Part Number Sequence ITS22-05-LP-DB-S-065-N20-T15-PV-060-S

ITS22 - 05 - LP - DB - S - 065 - N20 - T15 - PV - 060 - S

ITS22    Table 1    Table 2    Table 3    Table 4    Table 5    Table 6    Table 7    Table 8    Table 9    Table 10

Sensor Type & Style No.    Temp Range    Output    Probe Diameter    Probe Material    Probe Length    Extension Length    Fitting Type    Extension Cable Type    Extension Cable Length    Surface Finish

# Resistance Temperature Detectors

## THERMISTOR SENSOR

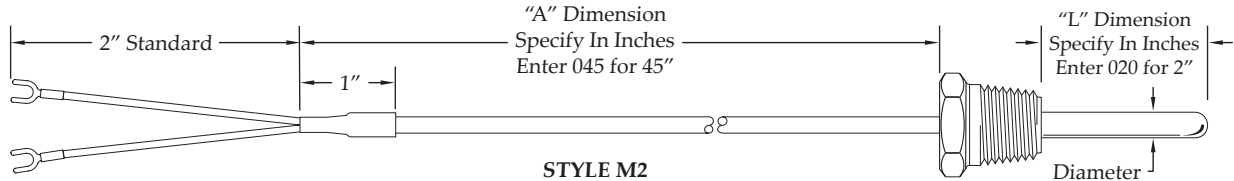
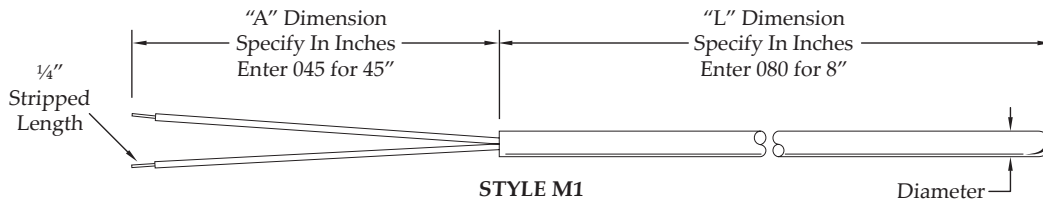

Code	Table 1: Element Type
1	10K ohm at 25°C
2	30K ohm at 25°C
3	50K ohm at 25°C
4	100K ohm at 25°C
5	500K ohm at 25°C

Code	Table 2: Element Tolerance
A	± 1% at 25°C
B	± 5% at 25°C
C	± 10% at 25°C
D	± 20% at 25°C

Code	Table 3: Sheath Material
4	304 Stainless Steel
6	316 Stainless Steel

Code	Table 4: Sheath Diameter
B	.125" or 1/8" Outer Diameter
V	.156" or 5/32" Outer Diameter
C	.188" or 3/16" Outer Diameter
D	.250" or 1/4" Outer Diameter

Code	Table 5: Sheath Length ("L" Dimension)
Specify in inches. See table on page 4 for codes.	

Code	Table 6: Lead Length ("A" Dimension)
Specify in inches. See table on page 4 for codes.	

Code	Table 7: Leadwire Type
A	Fiberglass Leadwire Singles
F	Teflon Leadwire Singles
G	Teflon Leadwire with Overall Teflon Jacket

Code	Table 8: Fitting Options
A	1/8" NPT Brass Bushing
B	1/8" NPT Stainless Steel Bushing
C	1/4" NPT Brass Bushing
D	1/4" NPT Stainless Steel Bushing
E	3/8" NPT Brass Bushing
F	3/8" NPT Stainless Steel Bushing
G	1/2" NPT Brass Bushing
H	1/2" NPT Stainless Steel Bushing
0	No Fitting (M1 Only)

Code	Table 9: Terminal Connectors
1	#6 Spade Lug
A	3/16" Disconnect
B	3/16" Disconnect, Insulated
C	1/4" Disconnect
D	1/4" Disconnect, Insulated
M	Mini Plug
X	Special, Specify

### Part Number Sequence

M2-3B-4B020-045AHC

M2	-	3	B	-	4	B	020	-	045	A	H	C
M1 or M2		Table 1	Table 2		Table 3	Table 4	Table 5		Table 6	Table 7	Table 8	Table 9
Sensor Type & Style No.		Element Type	Element Tolerance		Sheath Material	Sheath Diameter	"L" Sheath Length		"A" Lead Length	Leadwire Type	Fitting Options	Terminal Connectors



*closing the loop on thermal solutions*

# Resistance Temperature Detectors

## SPECIALTY SENSORS

### Air Temperature RTD's

The perforated tip of the air resistance temperature detector is designed for rapid monitoring of airflow temperature in various applications. Small film elements used in these housings can detect incremental changes more quickly than conventional housings. This construction can also be adapted to include special flanges and fittings, as well as custom connector options.

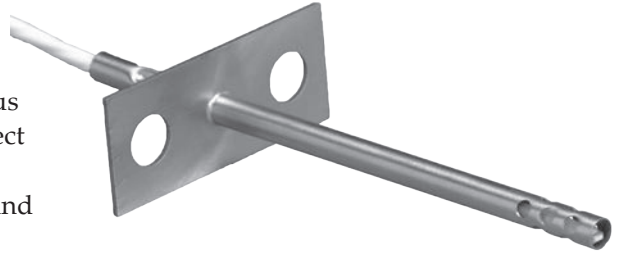

### Self Adhesive RTD's

If the surface being measured for temperature cannot be penetrated or if space limitations require it, Durex can provide an RTD with an adhesive patch for direct surface mounting. We routinely provide such sensors with special adhesive to accommodate temperature and vapor release requirements.



### Teflon®-Coated Probes

RTD's are available with Teflon® coated sheaths for applications that require contact temperature measurement in corrosive or chemical environments. The Teflon® coating can be applied directly to the sheath of the RTD, providing protection while minimizing effects to response. In applications that require considerable long-term protection, a welded Teflon® sleeve can be used adding as much as 1/16" thick of Teflon® protection to the surface of the probe. Flexible RTD designs are available, which encapsulate the entire length of the RTD for applications requiring long lengths of immersion.

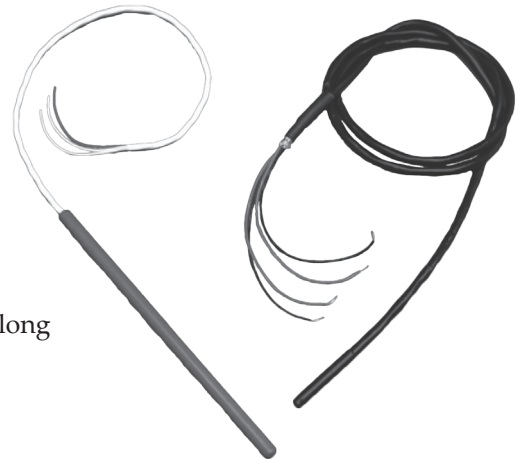

### Bendable RTD's

When an RTD needs to "snake" through an installation because of space limitations or other factors, Durex offers bendable elements with overbraid shielding or armor to suit the specifics of your application.

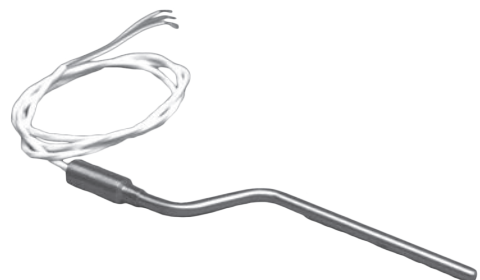



*closing the loop on thermal solutions*

# Resistance Temperature Detectors

## SPECIALTY SENSORS

### Flexible RTD's

Utilizing the same technology as a sealed Silicone Rubber heater, Durex offers a surface mount RTD sensor for direct mounting to flat or curved surfaces. The desing can be maintained in various thicknesses and supplied with an adhesive backing for quick application. A thinner profile can be used to wrap the sensor to curved surfaces such as cooling or water lines.

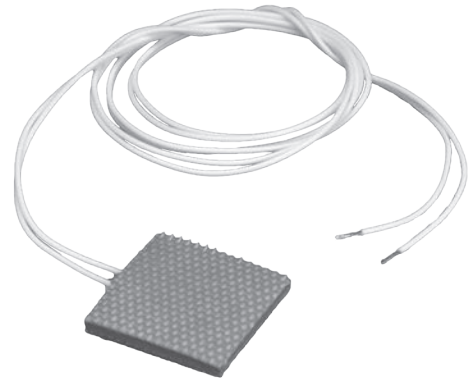

### Hand Held RTD's

Durex manufactures a line of multi-purpose hand held resistance temperature detectors for foodservice, industrial proces, and laboratory applications. Probe features include handles of stainless steel, Teflon®, or plastic and coil cord leadwires that can be constructed to withstand ambient temperatures up to 400°F. Standard designs include a mini plug connector, but many options are available. The RTD sheath itself is typically stainless steel and can be constructed with tips designed for piercing frozen meat, sensing gas temperatures, liquid immersion, or surface temperature measurements.



### Foodservice RTD's

Accuracy and reliability are the main requirements for probes designed for use in the foodservice industry. Robust designs that can handle the rigors of the industry are essential for long term performance. Durex has manufactured a wide variety of temperature sensors specifically for use in commercial cooking and food processing equipment. All probes are designed to the rigid specifications of the individual applications including such requirements as NSF, FDA, and UL/CSA. Customer designs are available in thermocouples, RTD's, or thermistors.

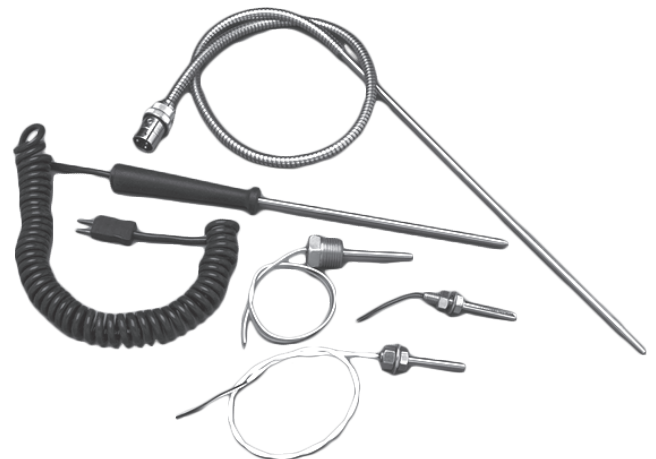





*closing the loop on thermal solutions*

# Industrial Process Thermocouples

## INTRODUCTION

Durex Industries manufactures a wide selection of industrial process thermocouples to meet the requirements of the most demanding process applications in the world such as steel processing, turbine and diesel engine temperature measurement, and chemical processing. In addition, Durex Industries also manufactures thermocouples that are built for commercial applications such as for foodservice, packaging, and semiconductor processing. These thermocouples are assembled under rigid quality control standards per ANSI specifications. Durex engineering can assist you with custom designed process thermocouples for your application.

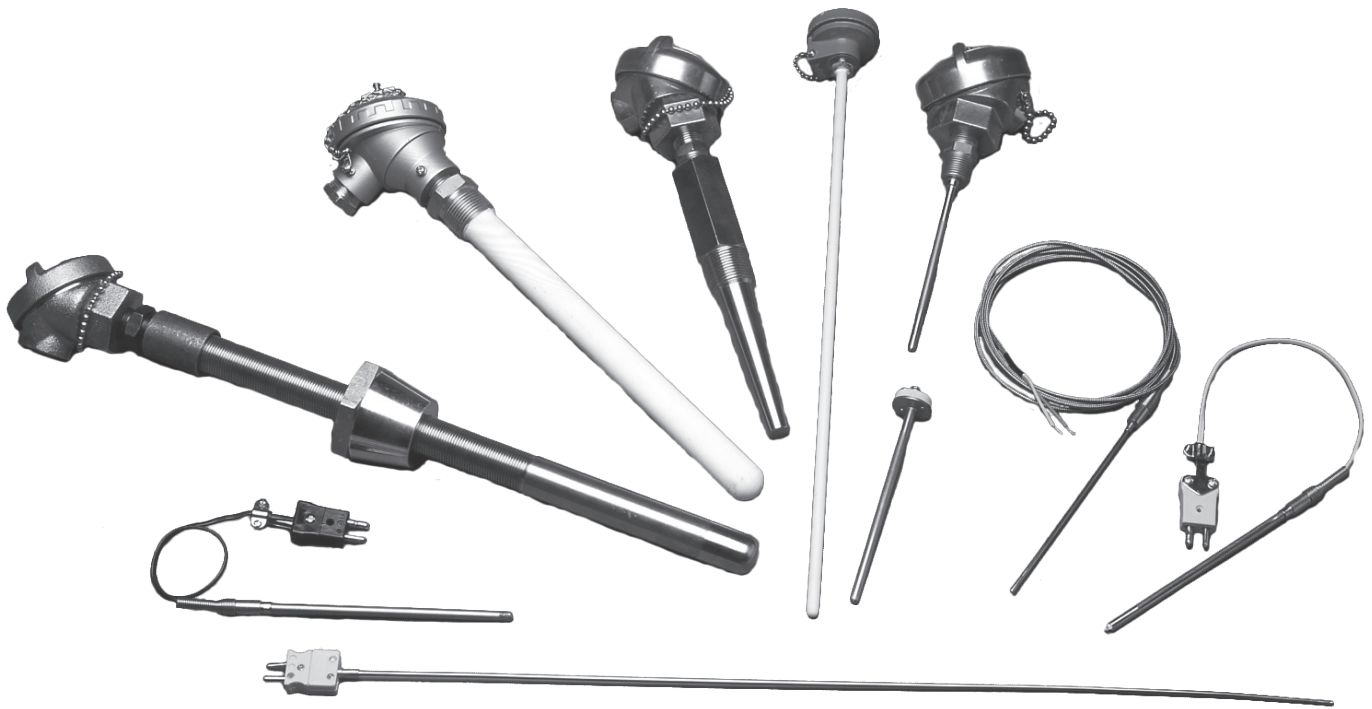

### **Design Features:**

- Various connection and mounting styles available
- Extreme high-temperature ranges
- Capable of handling direct immersion into high pressure or corrosive applications
- Utilized in heavy duty industrial applications
- Ideal for limited space requirements

### **Typical Applications:**

- Steel Processing
- Turbine and Diesel Engine
- Temperature Measurement
- Chemical Processing
- Foodservice
- Packaging
- Semiconductor Processing

## THERMOCOUPLE CALIBRATION

Durex offers testing at standard temperatures for determination of initial calibration tolerances for thermocouples. All calibration tests are fully traceable to the National Institute of Standards and Technology (NIST). Calibration is also available for application temperatures other than the standard points in a range from -100°F to 3000°F (-79°C to 1650°C) depending on material. Certificates are supplied for all items calibrated.

Calibration (T/C Type)	Temperatures Available	Applicable Specifications
E, J, K, N, T	32°F to 2300°F (0°C to 1250°C)	ASTM E 207 ASTM E 220
B, R, S	32°F to 3000°F (0°C to 1649°C)	ASTM E 230 ANSI MC 96.1
E, K, N, T	-320°F & -110°F to 23°F (-196°C & -79°C to 0°C)	

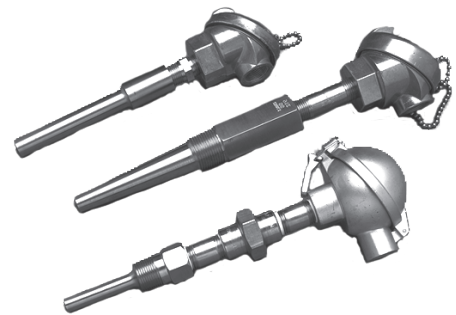

Durex manufactures thermocouple assemblies in the following calibrations:

ANSI Letter	Durex Code and Calibration	Calibration Description
Type E	<b>E</b> Chromel P-Constantan®	Standard Limits 32°F to 1652°F (0°C to 900°C) ± 1.7°C or ± 0.5% Tol. Special Limits 32°F to 1652°F (0°C to 900°C) ± 1.0°C or ± 0.4% Tol.
Type J	<b>J</b> Iron - Constantan®	Standard Limits 32°F to 1382°F (0°C to 750°C) ± 2.2°C or ± 0.75% Tol. Special Limits 32°F to 1382°F (0°C to 750°C) ± 1.1°C or ± 0.4% Tol.
Type K	<b>K</b> Chromel P-Alumel®	Standard Limits 32°F to 2282°F (0°C to 1250°C) ± 2.2°C or ± 0.75% Tol. Special Limits 32°F to 2282°F (0°C to 1250°C) ± 1.1°C or ± 0.4% Tol.
Type T	<b>T</b> Copper-Constantan®	Standard Limits 32°F to 662°F (0°C to 350°C) ± 1.0°C or ± 0.75% Tol. Special Limits 32°F to 662°F (0°C to 350°C) ± 0.5°C or ± 0.4% Tol.
Type N	<b>N</b> Nicrosil-NISIL	Standard Limits 32°F to 2282°F (0°C to 1250°C) ± 2.2°C or ± 0.75% Tol. Special Limits 32°F to 2282°F (0°C to 1250°C) ± 1.1°C or ± 0.4% Tol.
Type R	<b>R</b> Pt 13% Rhodium-Platinum	Standard Limits 32°F to 2642°F (0°C to 1450°C) ± 1.5°C or ± 0.25% Tol. Special Limits 32°F to 2642°F (0°C to 1450°C) ± 0.6°C or ± 0.1% Tol.
Type S	<b>S</b> Pt 10% Rhodium-Platinum	Standard Limits 32°F to 2642°F (0°C to 1450°C) ± 1.5°C or ± 0.25% Tol. Special Limits 32°F to 2642°F (0°C to 1450°C) ± 0.6°C or ± 0.1% Tol.
Type B	<b>B</b> Pt 30% Rhodium-Platinum 6% Rhodium	Standard Limits 1598°F to 3092°F (870°C to 1700°C) ± 0.5% Tol.

# Industrial Process Thermocouples

## JUNCTION TYPES



**EXPOSED (E)**  
Joined and welded wires.  
Specified where fast response is required.



**GROUNDED (G)**  
Junction is seal welded integrally to the sheath.  
Protects wire from corrosive conditions.



**UNGROUND (U)**  
Junction is electrically insulated from seal welded sheath. Design helps prevent stray EMF's.



**NECKDOWN (N)**  
Neckdown provides faster response.  
Junction can be single or dual circuit and grounded or ungrounded.



**PAD (P)**  
Pad is designed for welding directly to boiler or process tubes for sensing skin temperatures.

## SHEATH DIAMETERS

Sheath Code	T	Y	W	A	B	V	C	D	E	F	H
Sheath Diameter	.020"	.032"	.040"	.062"	.125"	.156"	.188"	.250"	.313"	.375"	.500"
Wire Gauge	38	34	33	30	24	22	20	18	16	15	11
Max. Length	100'	150'	200'	400'	250'	200'	175'	100'	55'	40'	30'

## PART NUMBER CODE DEFINITIONS

"L" Dimensions & "U" Dimensions				"A" Dimensions		Fractional Dimension Letter Code			
"L" and "U" dimensions are specified in whole inches and use a letter Code for the fraction. (Enter 0 when there is no fraction) Enter the three digit code per examples below:				"A" dimensions are specified in whole inches only. Enter the three digit code as follows:		1/16"	A	11/16"	L
						1/8"	B	3/4"	M
						3/16"	C	13/16"	N
						1/4"	D	7/8"	P
						5/16"	E	15/16"	R
						3/8"	F	1"	S
3"	030	10 5/8"	10K	9"	009	7/16"	G	0	No
4 1/2"	04H	12"	120	12"	012	1/2"	H	Fraction	
6 1/4"	06D	15 3/8"	15F	36"	036	9/16"	J		
7 7/8"	07P	17 3/4"	17M	144"	144	5/8"	K		
9 5/8"	09K	22 1/8"	22B						



*closing the loop on thermal solutions*

# Industrial Process Thermocouples

## SPECIFICATIONS

### Sheath

Materials: 304 Stainless Steel & Incoloy® 600 are most commonly used. See sheath materials tables on the following pages for the metal types used and their codes. Tolerances: Outside diameter  $\pm 0.002''$  of nominal size.

### Insulation

High purity magnesium oxide is standard; ultra high purity magnesium oxide and alumina oxide are available.

### Formability

Minimum radii: 2X sheath diameter for most thermocouple materials. Consult Durex Industries if special forming is required.

### Physical Testing

- Dimensional and visual
- Helium leak
- Radiographic (X-Ray)
- Dye penetration
- Metallurgical per ASTM E-2, E-3, and E-112
- Compaction density per RDT C2-IT

### ASTM Testing

Sheathed thermocouple material and sheathed thermocouples are tested using the following specifications:

- ASTM E585 Standard specifications for sheathed based-metal thermocouple materials.
- ASTM E608 Standard specifications for metal-sheathed base-metal thermocouples.
- ASTM E780 Standard method for measuring the insulation resistance of sheathed thermocouple-material at room temperature.
- ASTM E839 Standard test methods for sheathed thermocouples and sheathed thermocouple material.

### Insulation Resistance

Nominal Sheath Outside Diameter	Applied D.C. Voltage (min.)	Insulation Resistance Meg $\Omega$
.030" Diameter and smaller	50	100
.030" to .059" Diameter	50	500
.062" Diameter and larger	500	1000

### Finish

Bright annealed, 32 micro-inch or better.

### Configurations

Sheath diameters available from 0.020" to 0.500". Two wire (single circuit) and four wire (double circuit) configurations are standard in most diameters.

### Weldability

Thermocouple sheath can be brazed, soldered, or welded without loss of insulation resistance. Welding of special sheath materials by the customer is not recommended.

### Electrical Testing

- Calibration per ASTM E-220 traceable to NIST
- Insulation resistance
- Wire resistance (ohms per foot loop)
- Time response per RDT C2-3T
- Thermal cycling per ASTM E-225

# Industrial Process Thermocouples

## SHEATHED MgO THERMOCOUPLE ASSEMBLY WITH STRIPPED END

The TDC2 Style Thermocouple features an MgO insulated element which is junctioned and terminated with a standard 1" long strip. This style is designed for field replacement or addition of other termination options.

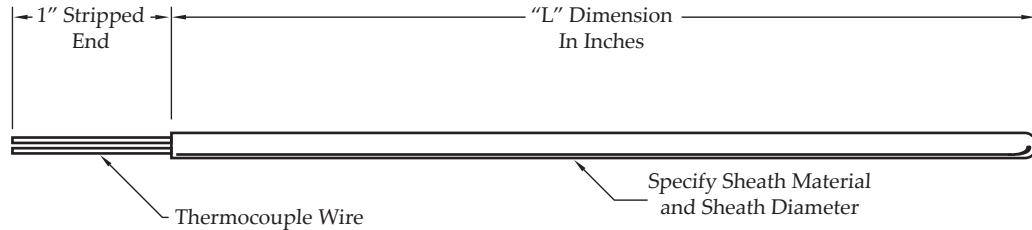

STYLE TDC2 - Stripped End MgO Thermocouple

Table 1: Thermocouple Type

Thermocouple Type Codes				Limits of Error
E	J	K	T	Standard Limits
2	3	4	8	Special Limits

Table 2: Junction Type

Code	Single Junction	Code	Dual Junction
G	Grounded	H	Grounded
U	Ungrounded	L	Ungrounded Isolated
C	Exposed	V	Ungrounded Common
		W	Exposed

Table 3: Sheath Material

Code	Metal Type
1	310 Stainless Steel
2	321 Stainless Steel
3	330 Stainless Steel
4	304 Stainless Steel
5	446 Stainless Steel
6	316 Stainless Steel
7	347 Stainless Steel
8	Inconel® 600 (Alloy 600)
A	Alloy 601

Table 4: Sheath Diameter

Code	O.D. Size
T	.020" O.D.
Y	.032" or 1/32" O.D.
W	.040" O.D.
A	.062" or 1/16" O.D.
B	.125" or 1/8" O.D.
V	.156" or 5/32" O.D.
C	.188" or 3/16" O.D.
D	.250" or 1/4" O.D.
E	.313" or 5/16" O.D.
F	.375" or 3/8" O.D.
H	.500" or 1/2" O.D.

Table 5: "L" Dimension

Specify in inches. See table on page 27 for codes.

### Part Number Sequence

TDC2-JG-4F100

TDC2	-	J	G	-	4	F	100
TDC2		Table 1	Table 2		Table 3	Table 4	Table 5
Sensor Type & Style No.		Thermocouple Type	Junction Type		Sheath Material	Sheath Diameter	"L" Dimension

# Industrial Process Thermocouples

## SHEATHED MgO THERMOCOUPLE ASSEMBLY WITH PLUG

The TDC3 Style Thermocouple features an MgO insulated element with universal disconnect plug for reliable connections. Plugs are available in standard (400°F), high temperature (800°F), and ceramic (1200°F) materials.

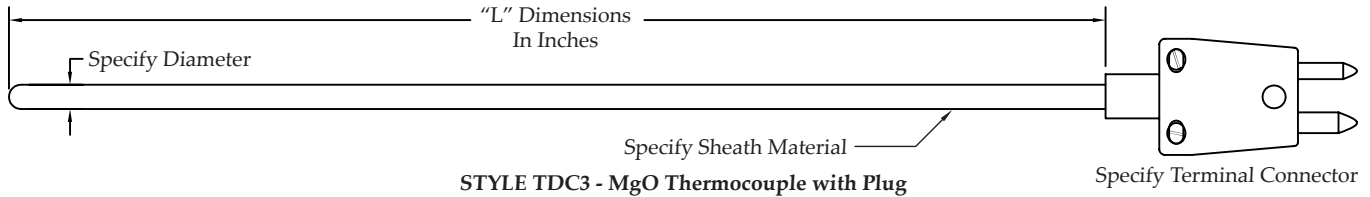

STYLE TDC3 - MgO Thermocouple with Plug

Specify Terminal Connector

Table 1: Thermocouple Type

Thermocouple Type Codes				Limits of Error
E	J	K	T	Standard Limits
2	3	4	8	Special Limits

Table 2: Junction Type

Code	Single Junction	Code	Dual Junction
G	Grounded	H	Grounded
U	Ungrounded	L	Ungrounded Isolated
C	Exposed	V	Ungrounded Common
		W	Exposed

Table 3: Sheath Material

Code	Metal Type
1	310 Stainless Steel
2	321 Stainless Steel
3	330 Stainless Steel
5	446 Stainless Steel
6	316 Stainless Steel
7	347 Stainless Steel
8	Inconel® 600 (Alloy 600)
A	Alloy 601

Table 4: Sheath Diameter

Code	O.D. Size
T	.020" O.D.
Y	.032" or 1/32" O.D.
W	.040" O.D.
A	.062" or 1/16" O.D.
B	.125" or 1/8" O.D.
V	.156" or 5/32" O.D.
C	.188" or 3/16" O.D.
D	.250" or 1/4" O.D.
E	.313" or 5/16" O.D.
F	.375" or 3/8" O.D.
H	.500" or 1/2" O.D.

Table 5: "L" Dimension

Specify in inches. See table on page 27 for codes.

Table 6: Terminal Connector

Code	Termination Style
3	Standard Molded Plug
6	Standard Plug with Brazing Adapter
7	Standard Plug with Tube Adapter
8	High Temperature Plug with Crimp Adapter
9	Ceramic Plug with Tube Adapter
F	Mini Molded Plug
M	Mini Plug with Crimp Adapter
X	Special, Specify

### Part Number Sequence

TDC3-JG-4F12F-3

TDC3	-	J	G	-	4	F	12F	-	3
TDC3		Table 1	Table 2		Table 3	Table 4	Table 5		Table 6
Sensor Type & Style No.		Thermocouple Type	Junction Type		Sheath Material	Sheath Diameter	"L" Dimension		Terminal Connector

# Industrial Process Thermocouples

## SHEATHED MgO THERMOCOUPLE ASSEMBLY WITH PROCESS HEAD

The TDC4 Style Thermocouple features an MgO insulated element with a protective terminal housing and process connector. This style can be manufactured as spring loaded for direct field replacement into existing thermowells.

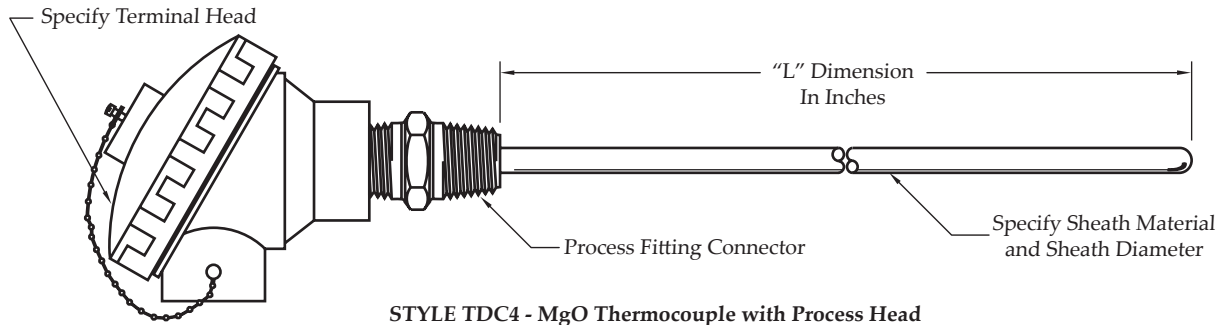

STYLE TDC4 - MgO Thermocouple with Process Head

Table 1: Thermocouple Type

Thermocouple Type Codes				Limits of Error
E	J	K	T	Standard Limits
2	3	4	8	Special Limits

Table 2: Junction Type

Code	Single Junction	Code	Dual Junction
G	Grounded	H	Grounded
U	Ungrounded	L	Ungrounded Isolated
C	Exposed	V	Ungrounded Common
		W	Exposed

Table 3: Sheath Material

Code	Metal Type
1	310 Stainless Steel
2	321 Stainless Steel
4	304 Stainless Steel
5	446 Stainless Steel
6	316 Stainless Steel
7	347 Stainless Steel
8	Inconel® 600 (Alloy 600)
A	Alloy 601

Table 4: Sheath Diameter

Code	O.D. Size
T	.020" O.D.
Y	.032" or 1/32" O.D.
W	.040" O.D.
A	.062" or 1/16" O.D.
B	.125" or 1/8" O.D.
V	.156" or 5/32" O.D.
C	.188" or 3/16" O.D.
D	.250" or 1/4" O.D.
E	.313" or 5/16" O.D.
F	.375" or 3/8" O.D.
H	.500" or 1/2" O.D.

Table 5: "L" Dimension

Specify in inches. See table on page 27 for codes.

Table 7: Spring Loaded Option

Code	Probe Tip Style
1	Fixed
2	Spring Loaded

Table 8: Screw Cover Terminal Heads

Code	Screw Cover Head Materials
A	1/2" NPT Conduit, Aluminum Head
B	3/4" NPT Conduit, Aluminum Head
C	1/2" NPT Conduit, Cast Iron Head
D	3/4" NPT Conduit, Cast Iron Head
M	1/4" NPT Conduit Connection, Miniature Plastic Head
P	1/2" NPT Conduit, Grey Delrin Head
R	3/4" NPT Conduit, Grey Delrin Head
W	1/2" NPT Conduit, White Polypropylene Head
V	3/4" NPT Conduit, White Polypropylene Head
Z	1/2" NPT Conduit, Explosion Proof Aluminum Head
Y	3/4" NPT Conduit, Explosion Proof Aluminum Head

Table 6: Fitting Options

Code	Process Size
0	No Process Connection
6	1/2" NPT Stainless Steel Hex Nipple
8	3/4" NPT Stainless Steel Hex Nipple
G	1/2" NPT Brass Hex Bushing
H	1/2" NPT Stainless Steel Hex Bushing

### Part Number Sequence TDC4-JG-6C060-61A0

TDC4	-	J	G	-	6	C	060	-	6	1	A	0
TDC4		Table 1	Table 2	Table 3	Table 4	Table 5	Table 6	Table 7	Table 8	Table 6		
Sensor Type & Style No.		Thermocouple Type	Junction Type	Sheath Material	Sheath Diameter	"L" Dimension	Fitting Options Into Head	Spring Loaded Option	Terminal Heads	Fitting Options On Probe		

# Industrial Process Thermocouples

## SHEATHED MgO THERMOCOUPLE ASSEMBLY WITH OPEN TERMINAL DISC

The TDC5 Style Thermocouple features an MgO insulated element with an open terminal disc design. This design allows greater accessibility in wiring for space restricted areas.

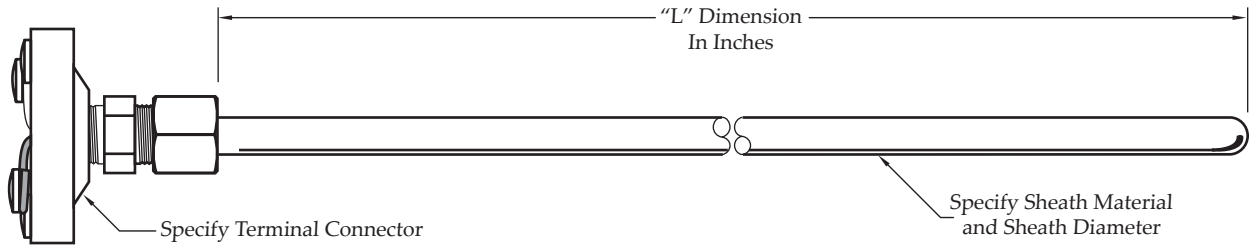

STYLE TDC5 - MgO Thermocouple with Open Terminal Disc

Table 1: Thermocouple Type

Thermocouple Type Codes				Limits of Error
E	J	K	T	Standard Limits
2	3	4	8	Special Limits

Table 2: Junction Type

Code	Single Junction	Code	Dual Junction
G	Grounded	H	Grounded
U	Ungrounded	L	Ungrounded Isolated
C	Exposed	V	Ungrounded Common
		W	Exposed

Table 3: Sheath Material

Code	Metal Type
1	310 Stainless Steel
2	321 Stainless Steel
4	304 Stainless Steel
5	446 Stainless Steel
6	316 Stainless Steel
7	347 Stainless Steel
8	Inconel® 600 (Alloy 600)
A	Alloy 601

Table 4: Sheath Diameter

Code	O.D. Size
T	.020" O.D.
Y	.032" or 1/32" O.D.
W	.040" O.D.
A	.062" or 1/16" O.D.
B	.125" or 1/8" O.D.
V	.156" or 5/32" O.D.
C	.188" or 3/16" O.D.
D	.250" or 1/4" O.D.
E	.313" or 5/16" O.D.
F	.375" or 3/8" O.D.
H	.500" or 1/2" O.D.

Table 5: "L" Dimension

Specify in inches. See table on page 27 for codes.

Table 6: Terminal Connector

Code	Termination Style
J	Circular Terminal Block, Ceramic
K	Circular Terminal Block, Glass Cloth
X	Special, Specify

### Part Number Sequence

TDC5-KG-4D09D-K

TDC5	-	K	G	-	4	D	09D	-	K
TDC5		Table 1	Table 2		Table 3	Table 4	Table 5		Table 6
Sensor Type & Style No.		Thermocouple Type	Junction Type		Sheath Material	Sheath Diameter	"L" Dimension		Terminal Connector



# Industrial Process Thermocouples

## SHEATHED MgO THERMOCOUPLE ASSEMBLY WITH INSULATED LEADWIRE

The TDC6 Style Thermocouple features an MgO insulated element that is terminated to an insulated extension wire. An optional terminal connector can be added to the extension wire.

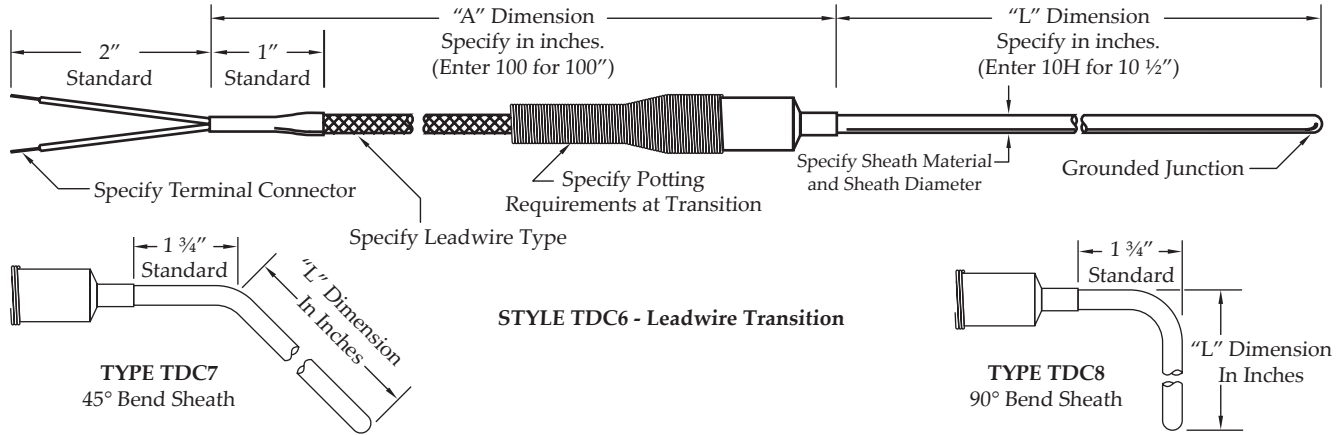

**Table 1: Thermocouple Type**

Thermocouple Type Codes				Limits of Error
E	J	K	T	Standard Limits
2	3	4	8	Special Limits

**Table 2: Junction Type**

Code	Single Junction	Code	Dual Junction
G	Grounded	H	Grounded
U	Ungrounded	L	Ungrounded Isolated
C	Exposed	V	Ungrounded Common
		W	Exposed

**Table 3: Sheath Material**

Code	Metal Type
1	310 Stainless Steel
2	321 Stainless Steel
4	304 Stainless Steel
5	446 Stainless Steel
6	316 Stainless Steel
7	347 Stainless Steel
8	Inconel® 600 (Alloy 600)
A	Alloy 601

**Table 4: Sheath Diameter**

Code	O.D. Size
T	.020" O.D.
Y	.032" or 1/32" O.D.
W	.040" O.D.
A	.062" or 1/16" O.D.
B	.125" or 1/8" O.D.
V	.156" or 5/32" O.D.
C	.188" or 3/16" O.D.
D	.250" or 1/4" O.D.
E	.313" or 5/16" O.D.
F	.375" or 3/8" O.D.
H	.500" or 1/2" O.D.

**Table 5: "L" Dimension**

Specify in inches. See table on page 27 for codes.

**Table 6: "A" Dimension**

Specify in inches. See table on page 27 for codes.

**Table 7: Leadwire Type & Construction**

Insulation Type	Conductor Type	Standard	Stainless Steel Overbraid	Stainless Steel Armor
Fiberglass	Solid	A	B	C
Teflon	Solid	D	E	F
Fiberglass	Stranded	G	H	J
Teflon	Stranded	K	L	M
Kapton	Solid	N	P	Q
PVC	Solid	R	S	T
PVC	Stranded	W	Y	Z

**Table 8: Terminal Connector**

Code	Termination Style
0	Split Leads, 2" Length Standard
1	3/16" Spade Lugs
3	Standard Plug
4	Standard Jack
M	Mini Plug
N	Mini Jack
X	Special, Specify

**Table 9: Potting Requirements**

Code	Maximum Temperatures
L	500°F
M	1000°F

**Part Number Sequence** TDC6-TG-6D08M-024C0M

TDC6	-	T	G	-	6	D	08M	-	024	C	0	M
TDC6		Table 1	Table 2	Table 3	Table 4	Table 5	Table 6	Table 7	Table 8	Table 9		

Sensor Type Thermocouple Junction Sheath Sheath "L" "A" Leadwire Terminal Potting & Style No. Type Type Material Diameter Dimension Dimension Construction Connector Requirements

# Industrial Process Thermocouples

## SHEATHED MgO MINI THERMOCOUPLE ASSEMBLY WITH MOLDED TRANSITION

The TDC9 Style Thermocouple features an MgO insulated element that is terminated to an insulated extension wire and encapsulated in a plastic injection molded "mini" transition using insert mold technology and a Liquid Crystal Polymer. Transition can withstand continuous exposure to temperatures up to 562°F.

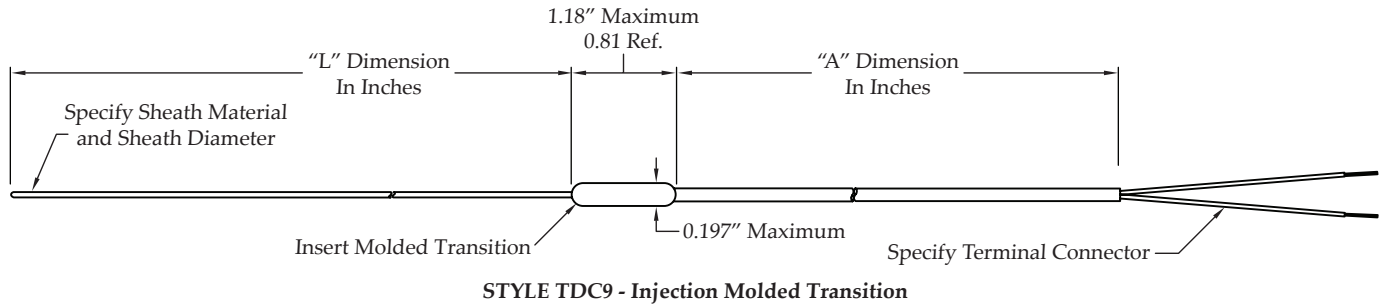

**Table 1: Thermocouple Type**

Thermocouple Type Codes				Limits of Error
E	J	K	T	Standard Limits
2	3	4	8	Special Limits

**Table 2: Junction Type**

Code	Single Junction
G	Grounded
U	Ungrounded
C	Exposed

**Table 3: Sheath Material**

Code	Metal Type
4	304 Stainless Steel
6	316 Stainless Steel
8	Inconel® 600 (Alloy 600)

**Table 4: Sheath Diameter**

Code	O.D. Size
T	.020" O.D.
Y	.032" or 1/32" O.D.
W	.040" O.D.
A	.062" or 1/16" O.D.
X	Special, Specify

**Table 5: "L" Dimension**

Specify in inches. See table on page 27 for codes.

**Table 6: "A" Dimension**

Specify in inches. See table on page 27 for codes.

**Table 7: Leadwire Type & Construction**

Insulation Type	Conductor Type	Standard
Fiberglass	Solid	A
Teflon	Solid	D
Fiberglass	Stranded	G
Teflon	Stranded	K
Kapton	Solid	N

**Table 8: Terminal Connector**

Code	Termination Style
0	Split Leads, 2" Length Standard
1	#6 Spade Lugs
3	Standard Plug
4	Standard Jack
X	Special, Specify

**Part Number Sequence** TDC9-TG-6T08M-024A0L

TDC9	-	T	G	-	6	T	08M	-	024	A	0
TDC9		Table 1	Table 2	Table 3	Table 4	Table 5	Table 6	Table 7	Table 8		
Sensor Type & Style No.		Thermocouple Type	Junction Type	Sheath Material	Sheath Diameter	"L" Dimension	"A" Dimension	Leadwire Construction	Terminal Connector		

# Industrial Process Thermocouples

## THERMOCOUPLE WITH THREADED THERMOWELL

The TDW1 and TDW2 Style Thermocouple assemblies feature a thermocouple element protected by a drilled bar stock thermowell. Various well materials and terminal heads are available as options. See next page for well selections.

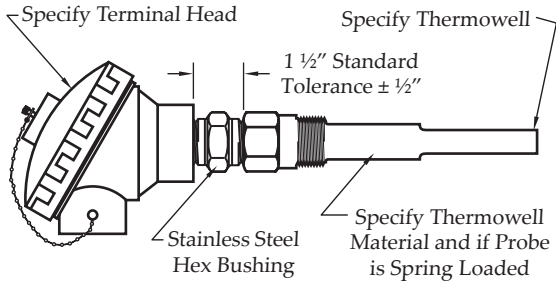

STYLE TDW1 - Nipple, Thermowell Assembly

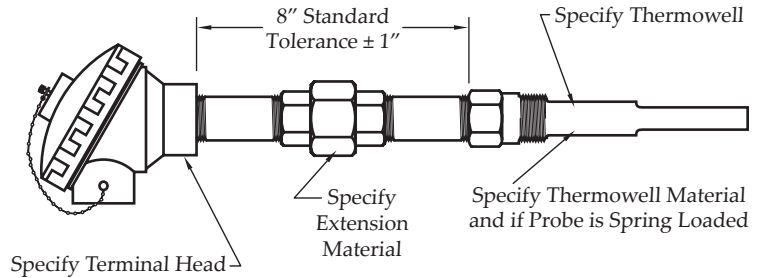

STYLE TDW2 - Nipple, Union, Nipple, Thermowell Assembly

Table 1: Thermocouple Type

Thermocouple Type Codes				Limits of Error
E	J	K	T	Standard Limits
2	3	4	8	Special Limits

Table 2: Element Type

Code	Metal Type
O	MI Cable, 18 Gauge, Single, Specify Junction GND/UNG
P	MI Cable, 18 Gauge, Dual, Specify Junction GND/UNG

Table 3: Well Material

Code	Metal Type
4	304 Stainless Steel
6	316 Stainless Steel
B	Brass
R	Carbon Steel

Table 4: Extension Material (TDW2 Only)

Code	Nipple Material
K	Black Pipe, Schedule 40
Y	Galvanized Steel
4	304 Stainless Steel
6	316 Stainless Steel

Table 5: Spring Loaded Option

Code	Probe Tip Style
1	Fixed Fitting
2	Spring Loaded Fitting

Table 6: Screw Cover Terminal Heads

Code	Screw Cover Head Materials
A	1/2" NPT Conduit, Aluminum Head
B	3/4" NPT Conduit, Aluminum Head
C	1/2" NPT Conduit, Cast Iron Head
D	3/4" NPT Conduit, Cast Iron Head
M	1/4" NPT Conduit Connection, Miniature Plastic Head
P	1/2" NPT Conduit, Grey Delrin Head
W	1/2" NPT Conduit, White Polypropylene Head
Z	1/2" NPT Conduit, Explosion Proof Aluminum Head
Y	3/4" NPT Conduit, Explosion Proof Aluminum Head

### Part Number Sequence

TDW2-KP-1207H6-Y1A

TDW2	-	K	P	-	1207H	6	-	Y	1	A
TDW2		Table 1	Table 2		See next page	Table 3		Table 4	Table 5	Table 6
Sensor Type & Style No.		Thermocouple Type	Element Type		Thermowell Number	Well Material		Extension Material	Spring Loaded Option	Terminal Heads

## THERMOWELL STYLES

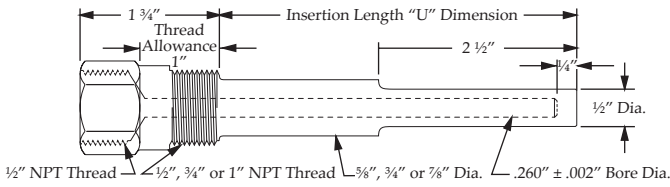

**Standard Well - Stepped Shank**

"U" Dim.	1/2" NPT	3/4" NPT	1" NPT
2 1/2"	1202H	1302H	1402H
4 1/2"	1204H	1304H	1404H
6"	12060	13060	14060
7 1/2"	1207H	1307H	1407H
10 1/2"	1210H	1310H	1410H
12"	12120	13120	14120
16 1/2"	1216H	1316H	1416H
22 1/2"	1222H	1322H	1422H

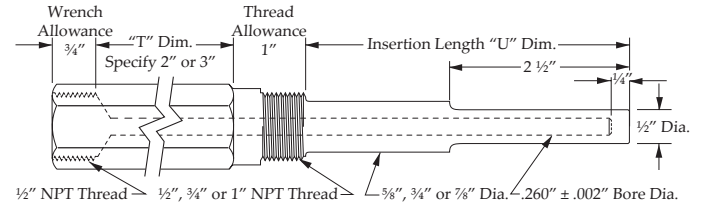

**Lagging Extension Well - Stepped Shank**

"U" Dim.	1/2" NPT	3/4" NPT	1" NPT
2 1/2"	2202H	2302H	2402H
4 1/2"	2204H	2304H	2404H
6"	22060	23060	24060
7 1/2"	2207H	2307H	2407H
10 1/2"	2210H	2310H	2410H
12"	22120	23120	24120
16 1/2"	2216H	2316H	2416H
22 1/2"	2222H	2322H	2422H

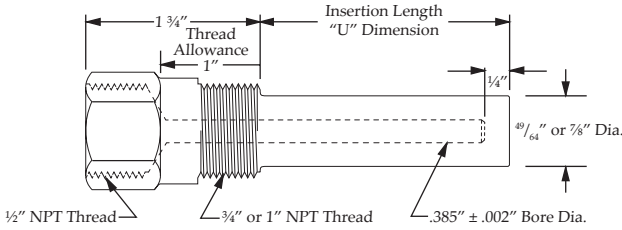

**Standard Well - Straight Shank**

"U" Dim.	3/4" NPT	1" NPT
2 1/2"	3302H	3402H
4 1/2"	3304H	3404H
6"	33060	34060
7 1/2"	3307H	3407H
10 1/2"	3310H	3410H
12"	33120	34120
16 1/2"	3316H	3416H
22 1/2"	3322H	3422H

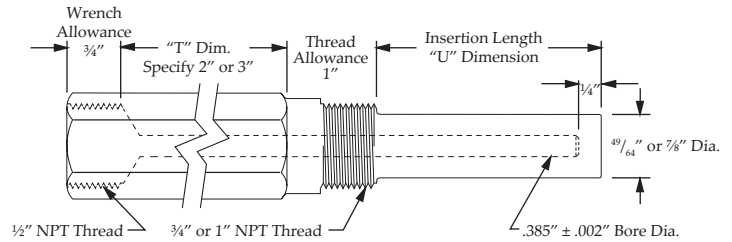

**Lagging Extension Well - Straight Shank**

"U" Dim.	3/4" NPT	1" NPT
2 1/2"	4302H	4402H
4 1/2"	4304H	4404H
6"	43060	44060
7 1/2"	4307H	4407H
10 1/2"	4310H	4410H
12"	43120	44120
16 1/2"	4316H	4416H
22 1/2"	4322H	4422H

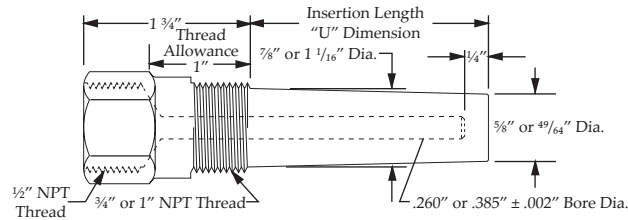

**Standard Well - Tapered Shank**

"U" Dim.	3/4" NPT		1" NPT	
	.260" Bore	.385" Bore	.260" Bore	.385" Bore
2 1/2"	5302H	6302H	5402H	6402H
4 1/2"	5304H	6304H	5404H	6404H
6"	53060	63060	54060	64060
7 1/2"	5307H	6307H	5407H	6407H
10 1/2"	5310H	6310H	5410H	6410H
12"	53120	63120	54120	64120
16 1/2"	5316H	6316H	5416H	6416H
22 1/2"	5322H	6322H	5422H	6422H

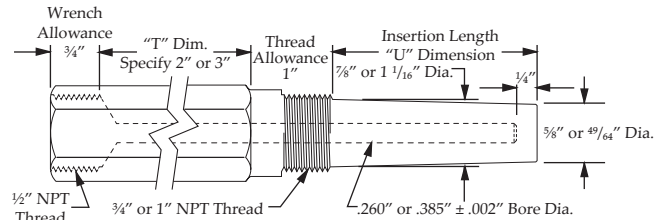

**Lagging Extension Well - Tapered Shank**

"U" Dim.	3/4" NPT		1" NPT	
	.260" Bore	.385" Bore	.260" Bore	.385" Bore
2 1/2"	7302H	8302H	7402H	8402H
4 1/2"	7304H	8304H	7404H	8404H
6"	73060	83060	74060	84060
7 1/2"	7307H	8307H	7407H	8407H
10 1/2"	7310H	8310H	7410H	8410H
12"	73120	83120	74120	84120
16 1/2"	7316H	8316H	7416H	8416H
22 1/2"	7322H	8322H	7422H	8422H

# Industrial Process Thermocouples

## THERMOCOUPLE WITH FLANGED THERMOWELL

The TDW3 and TDW4 Style Thermowell assemblies feature a thermocouple element protected by a flanged thermowell. Various well materials, flange materials, and sizes are available. See next page for well selection.

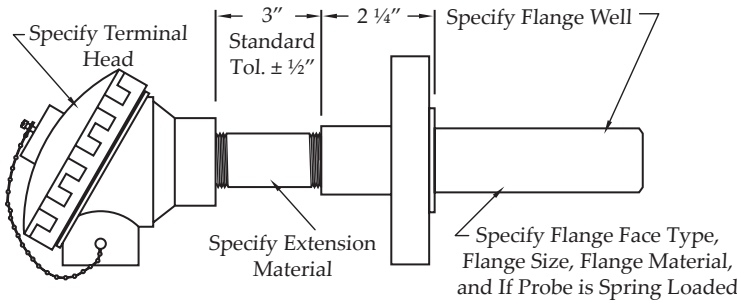

STYLE TDW3 - Fixed Flange Well

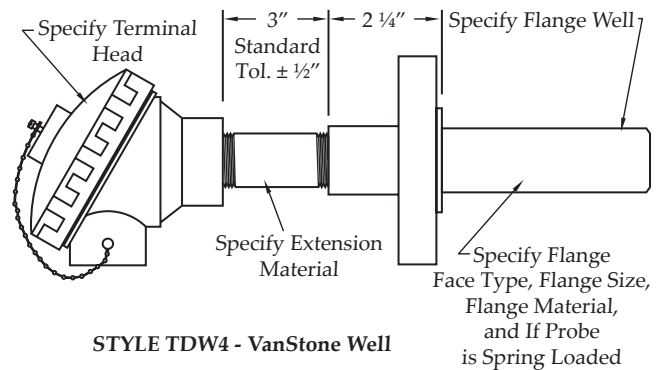

STYLE TDW4 - VanStone Well

Table 1: Thermocouple Type

Thermocouple Type Codes				Limits of Error
E	J	K	T	Standard Limits
2	3	4	8	Special Limits

Table 2: Element Type

Code	Metal Type
O	MI Cable, 18 Gauge, Single, Specify Junction GND/UNG
P	MI Cable, 18 Gauge, Dual, Specify Junction GND/UNG

Table 3: Flange Face Type

Code	Face Type
1	Raised Face
2	Flat Face

Table 4: Flange Size

Code	Flange Size (TDW3 Only)
D	1 1/2" Flange
E	2" Flange
F	2 1/2" Flange
G	3" Flange
H	4" Flange

Table 5: Well Material

Code	Metal Type
4	304 Stainless Steel
6	316 Stainless Steel
B	Brass
R	Carbon Steel

Table 6: Extension Material

Code	Nipple Material
K	Black Pipe, Schedule 40
Y	Galvanized Steel
4	304 Stainless Steel
6	316 Stainless Steel

Table 7: Spring Loaded Option

Code	Probe Tip Style
1	Fixed Fitting
2	Spring Loaded Fitting

Table 8: Screw Cover Terminal Heads

Code	Screw Cover Head Materials
A	1/2" NPT Conduit, Aluminum Head
B	3/4" NPT Conduit, Aluminum Head
C	1/2" NPT Conduit, Cast Iron Head
D	3/4" NPT Conduit, Cast Iron Head
Z	1/2" NPT Conduit, Explosion Proof Aluminum Head
Y	3/4" NPT Conduit, Explosion Proof Aluminum Head

**Part Number Sequence** TDW3-JP-F410701E4K1A

TDW3	-	J	P	-	F41070	1	E	4	K	1	A
TDW3		Table 1	Table 2	See next page	Table 3	Table 4	Table 5	Table 6	Table 7	Table 8	

Sensor Type Thermocouple Element Thermowell Flange Flange Well Extension Spring Loaded Terminal & Style No. Type Type Number Face Type Size Material Material Option Heads

## FLANGED THERMOWELL STYLES

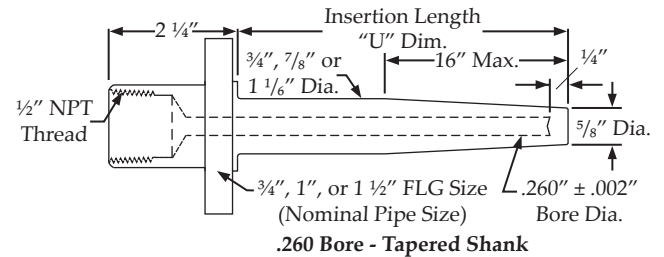
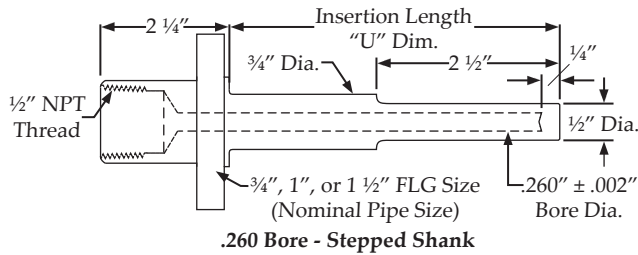

"U" Dim.	3/4" FLG Size	1" FLG Size	1 1/2" FLG Size
4"	F11040	F12040	F13040
7"	F11070	F12070	F13070
10"	F11100	F12100	F13100
13"	F11130	F12130	F13130
16"	F11160	F12160	F13160
22"	F11220	F12220	F13220

"U" Dim.	3/4" FLG Size	1" FLG Size	1 1/2" FLG Size
4"	F51040	F52040	F53040
7"	F51070	F52070	F53070
10"	F51100	F52100	F53100
13"	F51130	F52130	F53130
16"	F51160	F52160	F53160
22"	F51220	F52220	F53220

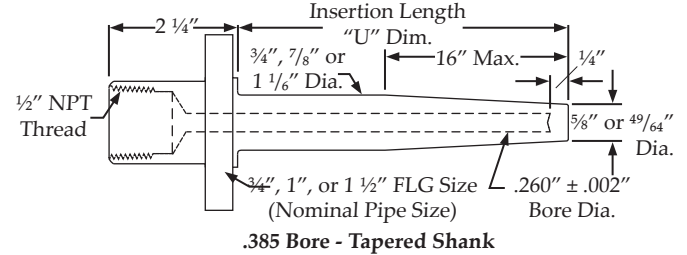
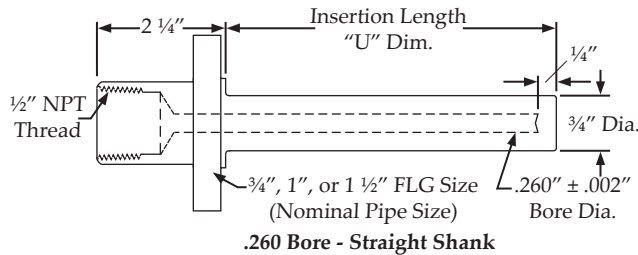

"U" Dim.	3/4" FLG Size	1" FLG Size	1 1/2" FLG Size
4"	F31040	F32040	F33040
7"	F31070	F32070	F33070
10"	F31100	F32100	F33100
13"	F31130	F32130	F33130
16"	F31160	F32160	F33160
22"	F31220	F32220	F33220

"U" Dim.	3/4" FLG Size	1" FLG Size	1 1/2" FLG Size
4"	F61040	F62040	F63040
7"	F61070	F62070	F63070
10"	F61100	F62100	F63100
13"	F61130	F62130	F63130
16"	F61160	F62160	F63160
22"	F61220	F62220	F63220

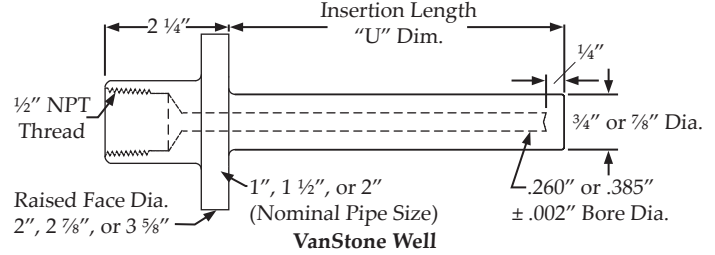
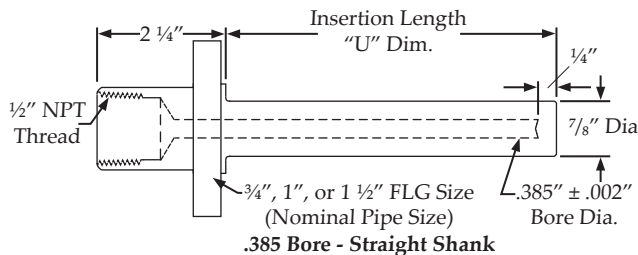

"U" Dim.	3/4" FLG Size	1" FLG Size	1 1/2" FLG Size
4"	F41040	F42040	F43040
7"	F41070	F42070	F43070
10"	F41100	F42100	F43100
13"	F41130	F42130	F43130
16"	F41160	F42160	F43160
22"	F41220	F42220	F43220

	"U" Dim.	1" NPS	1 1/2" NPS	2" NPS
.260 Bore	4"	F81040	F82040	F83040
	7"	F81070	F82070	F83070
	10"	F81100	F82100	F83100
	13"	F81130	F82130	F83130
	16"	F81160	F82160	F83160
	22"	F81220	F82220	F83220
.385 Bore	4"	F91040	F92040	F93040
	7"	F91070	F92070	F93070
	10"	F91100	F92100	F93100
	13"	F91130	F92130	F93130
	16"	F91160	F92160	F93160
	22"	F91220	F92220	F93220

Sensors

# Industrial Process Thermocouples

## BASE METAL PROTECTION TUBE ASSEMBLY

The TPT Style Thermocouple assemblies feature a base metal thermocouple and metal protection tube for use in corrosive or hostile environments. Optional mounting bushings and flanges are available.

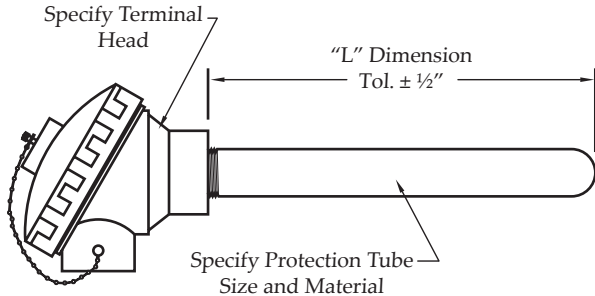

STYLE TPT - Metal Protection Tube

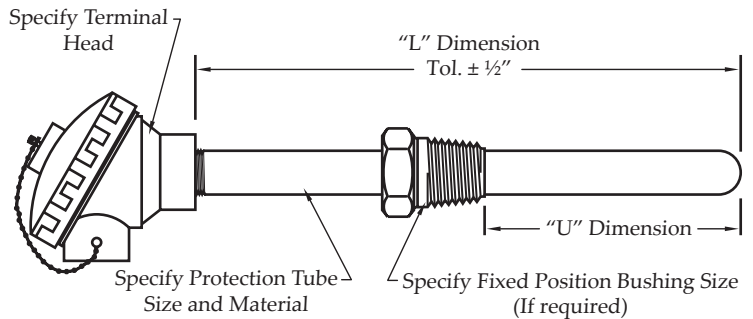

STYLE TPB - Metal Protection Tube with Process Bushing

Table 1: Thermocouple Type

Thermocouple Type Codes				Limits of Error
E	J	K	T	Standard Limits
2	3	4	8	Special Limits

Table 2: Element Type

Code	Metal Type
L	Beaded, 8 Gauge, Single, Specify Junction
M	Beaded, 14 Gauge, Single, Specify Junction
N	Beaded, 14 Gauge, Dual, Specify Junction
O	MI Cable, 18 Gauge, Single, Specify Junction GND/UNG
P	MI Cable, 18 Gauge, Dual, Specify Junction GND/UNG

Table 3: Protection Tube Size

Code	IPS (Nominal)
H	3/8" (.675)
L	1/2" (.840)
M	3/4" (1.050)
N	1" (1.315)
O	1 1/4" (1.660)
P	1 1/2" (1.900)

Table 4: Wall Thickness

Code	Nominal Wall
W	Schedule 40
Y	Schedule 80
Z	Schedule 160

Table 5: "U" Dimension

Specify in inches. See table on page 27 for codes.

Table 6: Protection Tube Materials

Code	Metal Materials
4	304 Stainless Steel
6	316 Stainless Steel
8	Inconel® 600
A	Inconel® 601
R	Carbon Steel

Table 7: "L" Dimension

Specify in inches. See table on page 27 for codes.

Table 8: Fitting Options

Code	Description
0	No fitting option
E	1/2" NPT Hex Bushing
F	3/4" NPT Hex Bushing
X	Special

Table 9: Fitting Material

Code	Description
4	304 Stainless Steel
6	316 Stainless Steel
B	Brass
R	Steel

Table 10: Screw Cover Terminal Heads

Code	Screw Cover Head Materials
A	1/2" NPT Conduit, Aluminum Head
B	3/4" NPT Conduit, Aluminum Head
C	1/2" NPT Conduit, Cast Iron Head
D	3/4" NPT Conduit, Cast Iron Head
M	1/4" NPT Conduit Connection, Miniature Plastic Head
P	1/2" NPT Conduit, Grey Delrin Head
W	1/2" NPT Conduit, White Polypropylene Head
Z	1/2" NPT Conduit, Explosion Proof Aluminum Head
Y	3/4" NPT Conduit, Explosion Proof Aluminum Head

### Part Number Sequence

TPT-EN-LW07H4-10F6A

TPT	-	E	N	-	L	W	07H	4	-	10H	F	6	A
TPT		Table 1	Table 2	Table 3	Table 4	Table 5	Table 6	Table 7	Table 8 & 9	Table 10			
Sensor Type & Style No.		Thermocouple Type	Element Type	Tube Size	Wall Thickness	"U" Dimension	Tube Material	"L" Dimension	Process Fitting	Terminal Heads			

# Industrial Process Thermocouples

## BASE METAL CERAMIC PROTECTION TUBE ASSEMBLY

The TPTC Style Thermocouple assemblies feature a base metal thermocouple element and ceramic protection tube for high temperature service. Ceramic mounting bushings are available.

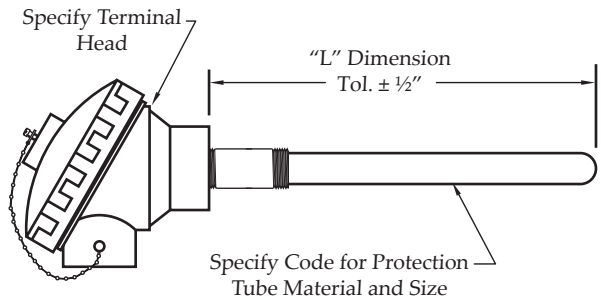

STYLE TPTC - Ceramic Protection Tube with Pipe Nipple

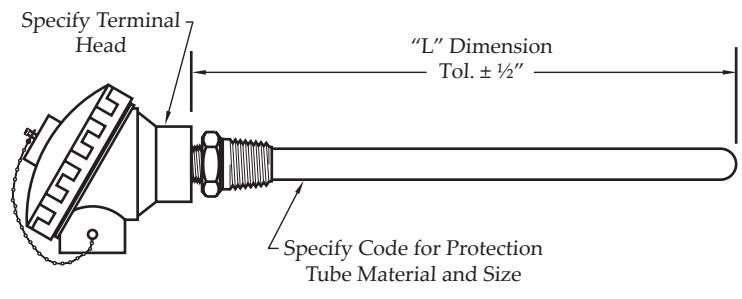

STYLE TPTC - Ceramic Protection Tube with Hex Fitting

Table 1: Thermocouple Type

Thermocouple Type Codes				Limits of Error
E	J	K	T	Standard Limits
2	3	4	8	Special Limits

Table 2: Element Type

Code	Metal Type
L	Beaded, 8 Gauge, Single, Specify Junction
M	Beaded, 14 Gauge, Single, Specify Junction
N	Beaded, 14 Gauge, Dual, Specify Junction
O	MI Cable, 18 Gauge, Single, Specify Junction GND/UNG
P	MI Cable, 18 Gauge, Dual, Specify Junction GND/UNG

Table 3: Ceramic Tube Size

Code	IPS (Nominal)
F	3/8" (.375)
L	11/16" (.688)
M	3/4" (.750)
P	7/8" (.875)
S	1" (1.00)

Table 4: Ceramic Material

Code	Materials
L	Alumina
W	Mullite

Table 5: "L" Dimension

Specify in inches. See table on page 27 for codes.

Table 6: Ceramic Process Connection

Code	Description
1	1/2" NPT Nipple
2	3/4" NPT Nipple
3	1/2" NPT Hex Nipple
4	3/4" NPT Hex Nipple
5	1/2" NPT N-U-N
6	3/4" NPT N-U-N

Table 7: Extension Material

Code	Metal Materials
4	304 Stainless Steel
6	316 Stainless Steel
B	Brass
K	Black Pipe
R	Steel

Table 8: Screw Cover Terminal Heads

Code	Screw Cover Head Materials
A	1/2" NPT Conduit, Aluminum Head
B	3/4" NPT Conduit, Aluminum Head
C	1/2" NPT Conduit, Cast Iron Head
D	3/4" NPT Conduit, Cast Iron Head
M	1/4" NPT Conduit Connection, Miniature Plastic Head
P	1/2" NPT Conduit, Grey Delrin Head
W	1/2" NPT Conduit, White Polypropylene Head
Z	1/2" NPT Conduit, Explosion Proof Aluminum Head
Y	3/4" NPT Conduit, Explosion Proof Aluminum Head

### Part Number Sequence

TPTC-KM-LL140-2KD

TPTC	-	K	M	-	L	L	140	-	2	K	D
TPTC		Table 1	Table 2		Table 3	Table 4	Table 5		Table 6	Table 7	Table 8
Sensor Type & Style No.		Thermocouple Type	Element Type		Ceramic Tube Size	Ceramic Material	"L" Dim.		Ceramic Process Conn.	Extension Material	Terminal Heads



# Industrial Process Thermocouples

## BASE METAL 90° PROTECTION TUBE ASSEMBLY

The TPA Style Thermocouple assembly features a base metal thermocouple element and metal protection tube with a 90° angle design for over-the-side application.

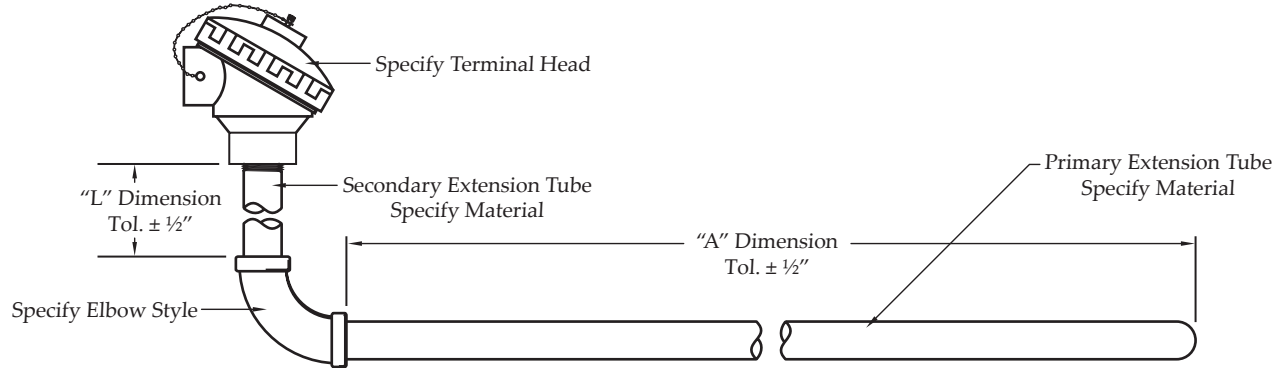

STYLE TPA - 90° Protection Tube

Table 1: Thermocouple Type

Thermocouple Type Codes				Limits of Error
E	J	K	T	Standard Limits
2	3	4	8	Special Limits

Table 2: Element Type

Code	Metal Type
L	Beaded, 8 Gauge, Single, Specify Junction
M	Beaded, 14 Gauge, Single, Specify Junction
N	Beaded, 14 Gauge, Dual, Specify Junction
O	MI Cable, 18 Gauge, Single, Specify Junction GND/UNG
P	MI Cable, 18 Gauge, Dual, Specify Junction GND/UNG

Table 3: Protection Tube Size

Code	IPS (Nominal)
L	1/2" (.840)
M	3/4" (1.050)
N	1" (1.315)
O	1 1/4" (1.660)
P	1 1/2" (1.900)

Table 4: Wall Thickness

Code	Nominal Wall
W	Schedule 40
Y	Schedule 80
Z	Schedule 160

Table 6: "L" Dimension

Specify in inches. See table on page 27 for codes.

Table 7: "A" Dimension

Specify in inches. See table on page 27 for codes.

Table 5: Protection Tube Materials

Code	Metal Materials
4	304 Stainless Steel
6	316 Stainless Steel
5	446 Stainless Steel
8	Inconel® 600
A	Inconel® 601
R	Carbon Steel

Table 9: Screw Cover Terminal Heads

Code	Screw Cover Head Materials
A	1/2" NPT Conduit, Aluminum Head
B	3/4" NPT Conduit, Aluminum Head
C	1/2" NPT Conduit, Cast Iron Head
D	3/4" NPT Conduit, Cast Iron Head
M	1/4" NPT Conduit Connection, Miniature Plastic Head
P	1/2" NPT Conduit, Grey Delrin Head
W	1/2" NPT Conduit, White Polypropylene Head
Z	1/2" NPT Conduit, Explosion Proof Aluminum Head
Y	3/4" NPT Conduit, Explosion Proof Aluminum Head

Table 8: Elbow Style

Code	Elbow Type
F	Fixed Elbow

### Part Number Sequence TPA-JL-LW406H-410HFB

TPA	-	J	L	-	L	W	4	06H	-	4	10H	F	B
TPA		Table 1	Table 2	Table 3	Table 4	Table 5	Table 6	Table 5	Table 7	Table 8	Table 9		

Sensor Type Thermocouple Element Tube Wall Primary Tube "L" Secondary "A" Elbow Terminal & Style No. Type Type Size Thickness Material Dim. Tube Material Dim. Style Head

# Industrial Process Thermocouples

## BASE METAL THERMOCOUPLE ELEMENTS

The TEBA and TEBD Style Thermocouples are base metal replacement elements for all ceramic or metal protection tube assemblies.

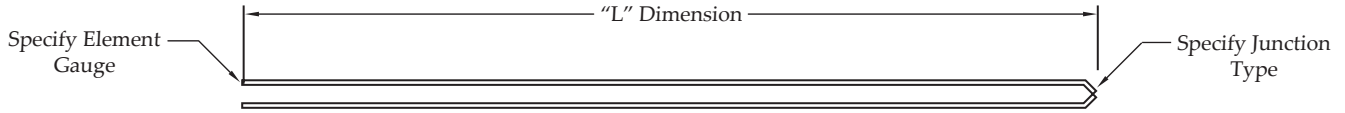

STYLE TEBA - Bare Element Thermocouple

Table 1: Thermocouple Type

Thermocouple Type Codes				Limits of Error
E	J	K	T	Standard Limits
2	3	4	8	Special Limits

Table 2: Junction Type

Code	Single Junction
B	Buttwelded
D	Twisted & Welded

Table 3: Bare Element Gauge

Code	Thermocouple Wire Gauge Size
08	8 Gauge
14	14 Gauge
20	20 Gauge
24	24 Gauge

Table 5: Termination

Code	Termination
0	2" Split Ends
1	#6 Spade Lug
3	Standard Plug
M	Mini Plug

Table 4: "L" Dimension

Specify in inches. See table on page 27 for codes.

### Part Number Sequence TEBA-JB-080022H0

TEBA	-	J	B	-	08	00	22H	0
TEBA		Table 1	Table 2		Table 3		Table 4	Table 5
Sensor Type & Style No.		Thermocouple Type	Junction Type		Bare Element Gauge		"L" Dimension	Termination

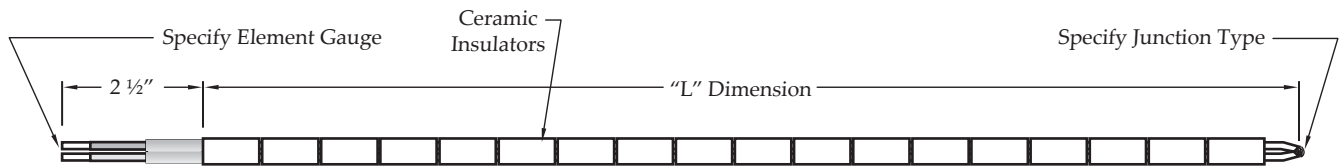

STYLE TEBD - Insulated Thermocouple

Table 1: Thermocouple Type

Thermocouple Type Codes				Limits of Error
E	J	K	T	Standard Limits
2	3	4	8	Special Limits

Table 2: Junction Type

Code	Single Junction
B	Buttwelded
D	Twisted & Welded
Code	Dual Junction
F	Buttweld, 14 GA & 20 GA only
M	Twisted & Welded, 14 GA & 20 GA only

Table 3: Element Gauge

Code	Thermocouple Wire Gauge Size
08	8 Gauge
14	14 Gauge
20	20 Gauge
24	24 Gauge

Table 4: Insulator Type

Code	Description
1	Single Round Insulator
2	1" Long Oval Insulator
3	1" Long Round Insulator
4	3" Long Round Insulator
5	3" Long Oval Insulator

Table 5: Insulator Material

Code	Description
A	Alumina
M	Mullite
C	Ceramic

Table 6: "L" Dimension

Specify in inches. See table on page 27 for codes.

Table 7: Termination

Code	Termination
0	2" Split Ends
1	#6 Spade Lug
3	Standard Plug
M	Mini Plug

### Part Number Sequence TEBD-JB-081M22H0

TEBD	-	J	B	-	08	1	M	22H	0
TEBD		Table 1	Table 2		Table 3	Table 4	Table 5	Table 6	Table 7
Sensor Type & Style No.		Thermocouple Type	Junction Type		Bare Element Gauge	Insulator Type	Insulator Material	"L" Dimension	Termination

# Industrial Process Thermocouples

## BASE METAL THERMOCOUPLE ELEMENTS

The TEAB Style Thermocouple is a replacement element for the TPA 90° angle protection tube thermocouple assembly.

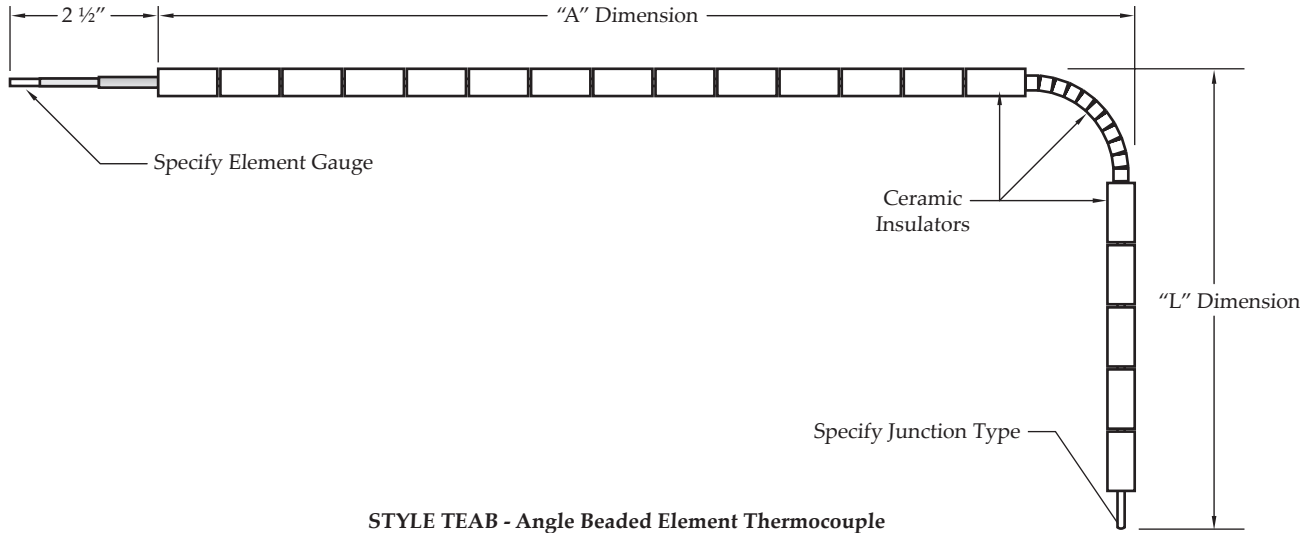

STYLE TEAB - Angle Beaded Element Thermocouple

Table 1: Thermocouple Type

Thermocouple Type Codes				Limits of Error
E	J	K	T	Standard Limits
2	3	4	8	Special Limits

Table 2: Junction Type

Code	Single Junction
B	Buttwelded
D	Twisted & Welded

Table 3: Bare Element Gauge

Code	Thermocouple Wire Gauge Size
08	8 Gauge
14	14 Gauge
20	20 Gauge

Table 4: "L" Dimension

Specify in inches. See table on page 27 for codes.

Table 5: "A" Dimension

Specify in inches. See table on page 27 for codes.

### Part Number Sequence

TEAB-JB-1412D-32M

TEAB	-	J	B	-	14	12D	-	32M
TEAB		Table 1	Table 2		Table 3	Table 4		Table 5
Sensor Type & Style No.		Thermocouple Type	Junction Type		Bare Element Gauge	"L" Dimension		"A" Dimension

# Industrial Process Thermocouples

## NOBLE METAL THERMOCOUPLE ELEMENTS

The TENE Style Thermocouple is a noble metal element designed as a replacement for high temperature protection tube assemblies.

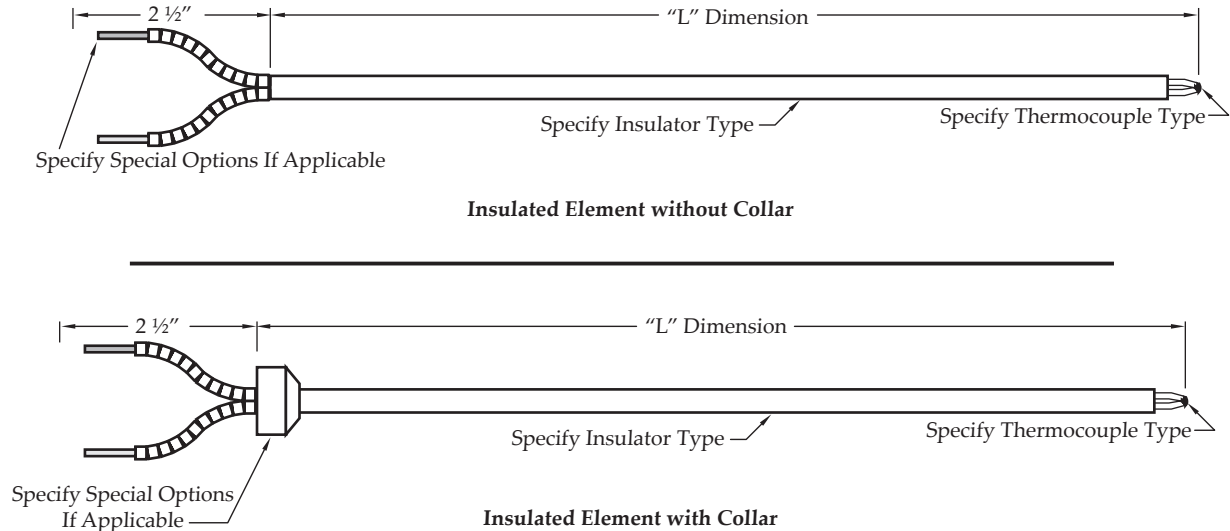

STYLE TENE - Noble Metal Element Thermocouple

Table 1: Thermocouple Quantity

Code	Description
S	Single
D	Dual

Table 2: Calibration Type

Code	Size
R	R Calibration
S	S Calibration
B	B Calibration
C	C Calibration

Table 3: Insulator Size

Code	Size
B	1/8" (.125")
C	3/16" (.188")
D	1/4" (.250")

Table 4: Insulator Material

Code	Description
A	Alumina
M	Mullite

Table 5: "L" Dimension

Specify in inches. See table on page 27 for codes.

Table 6: Element Position

Code	Description
S	Surface
R	Recessed

Table 7: Collar

Code	Description
0	No Collar
C	Collar

Table 8: Limits of Error

Code	Description
0	Standard
L	Special

Table 9: Termination

Code	Termination
0	2" Split Ends
1	#6 Spade Lug
3	Standard Plug
M	Mini Plug

### Part Number Sequence

TENE-SR24-CM06H0000

TENE - S R 24 - C M 06H 0 0 0 0

TENE Table 1 Table 2 Table 3 Table 4 Table 5 Table 6 Table 8 Table 7 Table 9

Sensor Type Thermocouple Calibration Gauge Insulator Insulator "L" Element Limits Collar Termination  
& Style No. Quantity Type Size Material Dimension Position of Error

# Industrial Process Thermocouples

## NOBLE METAL THERMOCOUPLE WITH SINGLE CERAMIC TUBE

The TSPT Style Thermocouple assembly features a noble metal thermocouple and single ceramic protection tube. A variety of process connection and terminal housing options are available.

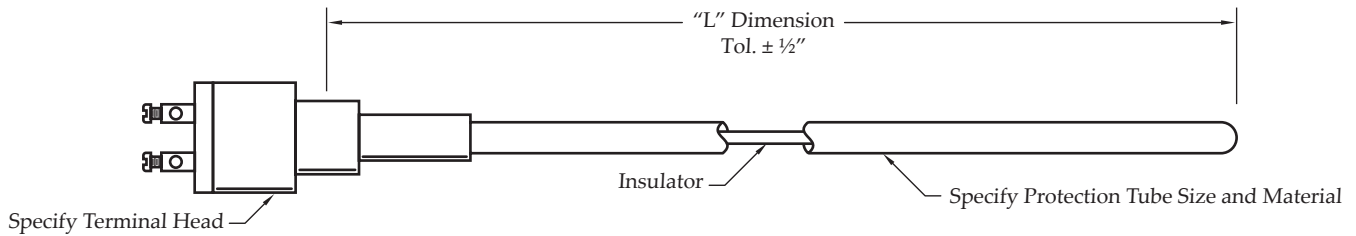

STYLE TSPT - Single Tube Assembly

Table 1: Thermocouple Type

Element Type and Gauge			
Code	T/C Quantity	Calibration Type	Gauge
SR24	Single	R	24
SS24	Single	S	24
SB24	Single	B	24
DR24	Dual	R	24
DS24	Dual	S	24
DB24	Dual	B	24

Table 2: Protection Tube

Code	Size/Material
A	3/8 OD Mullite
B	3/8 OD Alumina
C	11/16 OD Mullite
D	11/16 OD Alumina
X	Special

Table 3: "L" Dimension

Specify in inches. See table on page 27 for codes.

Table 4: Process Connection

Code	Description
0	No Process Fitting
G	1/2" NPT, Brass Bushing
H	1/2" NPT, Stainless Steel Bushing
J	3/4" NPT, Brass Bushing
K	3/4" NPT, Stainless Steel Bushing

Table 5: Termination Options

Code	Termination Type
K	Open Head Brass Terminal
B	3/4" NPT Conduit, Aluminum Head
C	1/2" NPT Conduit, Cast Iron Head

### Part Number Sequence

TSPT-SR24-C06H-KB

TSPT	-	SR24	-	C	06H	-	K	B
TSPT		Table 1		Table 2	Table 3		Table 4	Table 5
Sensor Type & Style No.		Thermocouple Type		Protection Tube	"L" Dimension		Process Connection	Termination Options

# Industrial Process Thermocouples

## NOBLE METAL THERMOCOUPLE WITH DOUBLE CERAMIC TUBE

The TDPT Style Thermocouple assembly features a noble metal thermocouple element with a primary and secondary ceramic protection tube for additional protection in extreme environments.

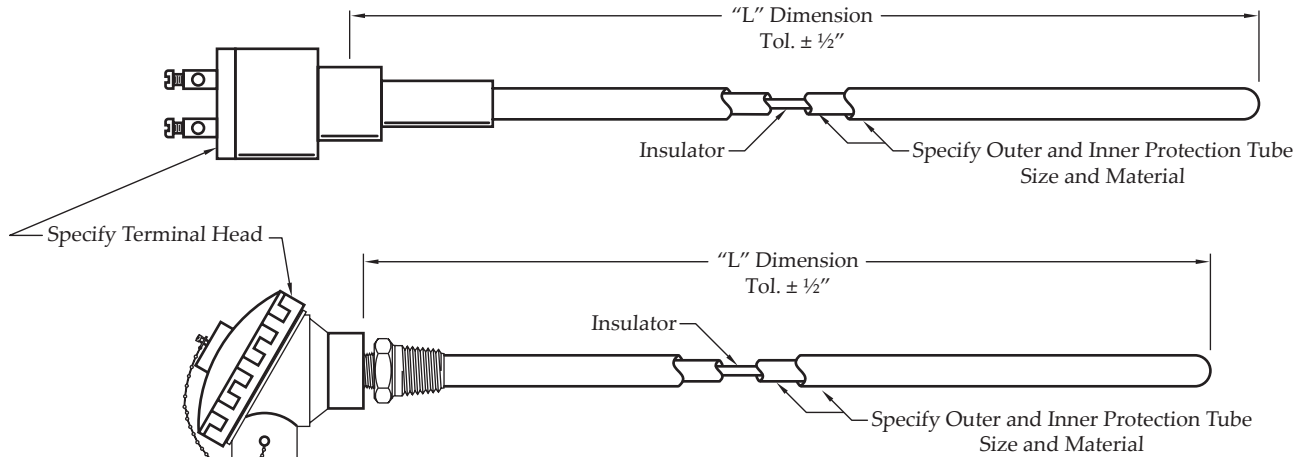

STYLE TDPT - Double Tube Assembly

Table 1: Thermocouple Type

Element Type and Gauge			
Code	T/C Quantity	Calibration Type	Gauge
SR24	Single	R	24
SS24	Single	S	24
SB24	Single	B	24
DR24	Dual	R	24
DS24	Dual	S	24
DB24	Dual	B	24

Table 2: Outer Protection Tube

Code	Size/Material
LL	1 <sup>1</sup> / <sub>16</sub> OD Alumina
LW	1 <sup>1</sup> / <sub>16</sub> OD Mullite
PZ	7 <sup>8</sup> / <sub>16</sub> OD LT-1
UA	1.05" OD Inconel <sup>®</sup> 601

Table 3: "L" Dimension  
Specify in inches.  
See table on page 27 for codes.

Table 4: Inner Protection Tube

Code	Size
F	3/8" Diameter

Table 5: Process Connection

Code	Description
0	No Process Fitting
G	1/2" NPT, Brass Bushing
H	1/2" NPT, Stainless Steel Bushing
J	3/4" NPT, Brass Bushing
K	3/4" NPT, Stainless Steel Bushing

Table 6: Termination Options

Code	Termination Type
K	Open Head Brass Terminal
B	3/4" NPT Conduit, Aluminum Head
D	3/4" NPT Conduit, Cast Iron Head

### Part Number Sequence

TDPT-SR24-LL06HF-KB

TDPT	-	SR24	-	LL	06H	F	-	K	B
TDPT		Table 1		Table 2	Table 3	Table 4		Table 5	Table 6
Sensor Type & Style No.		Thermocouple Type		Outer Protection Tube	"L" Dimension	Inner Protection Tube		Process Connection	Termination Options

# Industrial Process Thermocouples

## REPLACEMENT CERAMIC PROTECTION TUBES

Replacement ceramic protection tubes are available for all thermocouple protection tube assemblies.

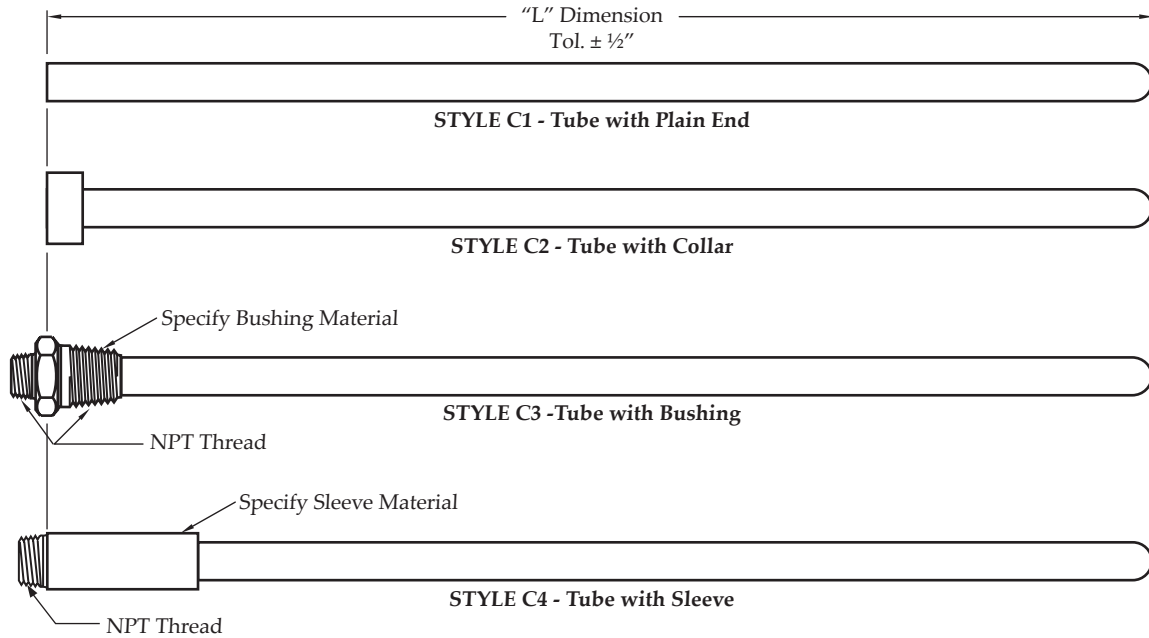

**Table 1: Tube Material**

Code	Material
W	Mullite
L	Alumina

**Table 2: Tube Size**

Code	Description
D	3/16" ID x 1/4" OD
F	1/4" ID x 3/8" OD
H	3/8" ID x 1/2" OD
L	7/16" ID x 11/16" OD
S	3/4" ID x 1" OD
Q	1" ID x 1 1/4" OD

**Table 4: Fitting Options**

Code	Description
0	No Fitting Option
1	1/2" x 1/2" NPT Hex Nipple
2	3/4" x 1/2" NPT Hex Nipple
3	3/4" x 3/4" NPT Hex Nipple
4	1" x 3/4" NPT Hex Nipple
5	1" x 1" NPT Hex Nipple
6	1 1/4" x 1" NPT Hex Nipple
7	7/8 - 27 Sleeve
8	1/2" Schedule 40 Pipe
9	1/2" NPT Schedule 40 Pipe
A	3/4" Schedule 40 Pipe
B	3/4" NPT Schedule 40 Pipe
C	1" Schedule 40 Pipe
D	1" NPT Schedule 40 Pipe
E	3/4" x 1/2" NPT Hex Bushing
F	1" x 3/4" NPT Hex Bushing
G	1 1/4" x 1" NPT Hex Bushing

**Table 3: "L" Dimension**

Specify in inches. See table on page 27 for codes.

**Table 5: Fitting Material**

Code	Material
0	No Fitting
4	304 Stainless Steel
6	316 Stainless Steel
B	Brass
K	Black Pipe
R	Carbon Steel

### Part Number Sequence

C1-WF06H-B4

C3	-	W	F	06H	-	B	4
C3		Table 1	Table 2	Table 3		Table 4	Table 5
Sensor Type & Style No.		Tube Material	Tube Size	"L" Dimension		Fitting Options	Fitting Material

## REPLACEMENT METAL PROTECTION TUBES

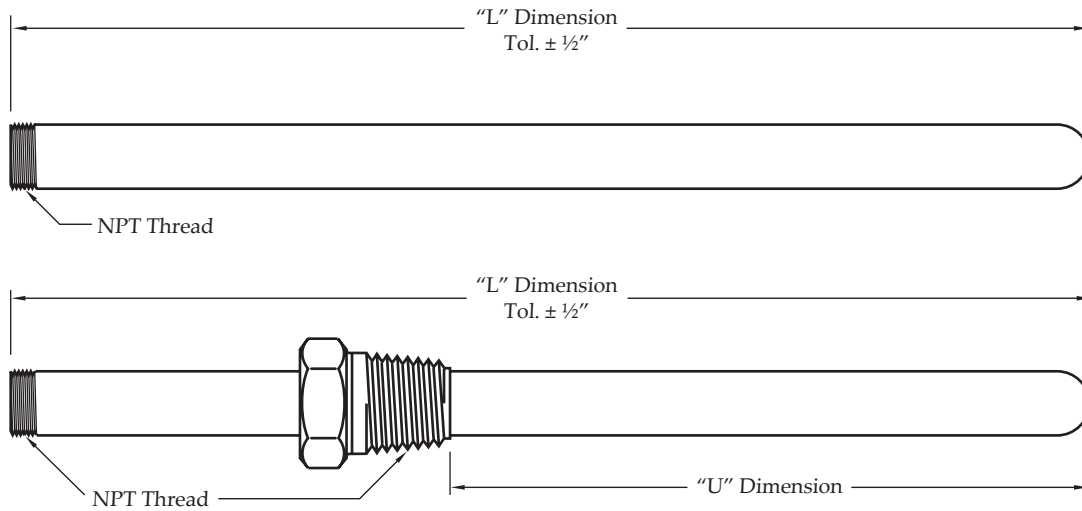

STYLE RP2 - Tube With Fixed Bushing

Table 1: Protection Tube Size

Code	ISP (Nominal)
L	1/2" (.840)
M	3/4" (1.050)
N	1" (1.315)
O	1 1/4" (1.660)
P	1 1/2" (1.900)

Table 2: Wall Thickness

Code	Nominal Wall
W	Schedule 40
Y	Schedule 80
Z	Schedule 160

Table 3: Tube Materials

Code	Material
1	310 Stainless Steel
4	304 Stainless Steel
5	446 Stainless Steel
6	316 Stainless Steel
8	Inconel® 600

Table 5: Fitting Options

Code	Description
0	No Fitting Option
1	1/2" x 1/2" NPT Hex Nipple
2	3/4" x 1/2" NPT Hex Nipple
3	3/4" x 3/4" NPT Hex Nipple
4	1" x 3/4" NPT Hex Nipple
5	1" x 1" NPT Hex Nipple
6	1" x 1 1/4" NPT Hex Nipple
B	1/8" NPT Bushing
C	1/4" NPT Bushing
D	3/8" NPT Bushing
E	1/2" NPT Bushing
F	3/4" NPT Bushing
G	1" NPT Bushing

Table 6: Fitting Material

Code	Material
0	No Fitting
4	304 Stainless Steel
6	316 Stainless Steel
B	Brass
D	Copper
K	Black Pipe
R	Steel

Table 4: "L" Dimension

Specify in inches. See table on page 27 for codes.

Table 7: "U" Dimension

Specify in inches. See table on page 27 for codes.

### Part Number Sequence RP2-LW406H-B4000

RP2	-	L	W	4	06H	-	B	4	000
RP2		Table 1	Table 2	Table 3	Table 4		Table 5	Table 6	Table 7
Sensor Type & Style No.		Tube Size	Wall Thickness	Tube Material	"L" Dimension		Fitting Options	Fitting Material	"U" Dimension



# Industrial Process Thermocouples

## SILICON CARBIDE PROTECTION TUBE ASSEMBLY

The PSC1 and PSC2 Style Thermocouple assemblies feature a silicon carbide protection tube along with an inner ceramic tube for additional protection of the element.

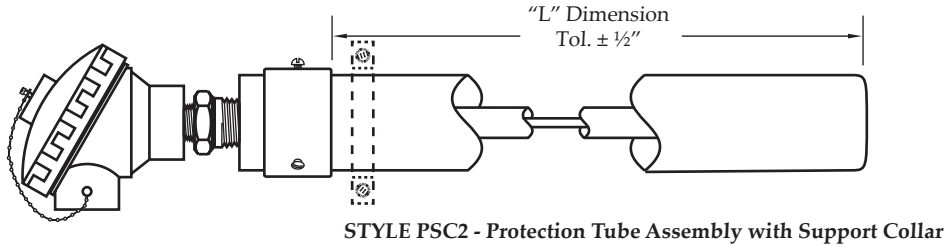
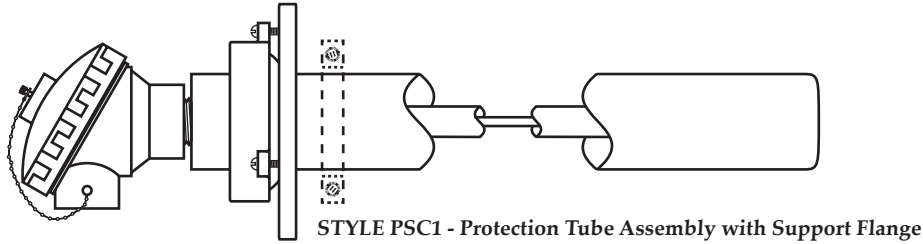

**Table 1: Thermocouple Type**

Element Type and Gauge	
Single	Dual
SR24	DR24
SS24	DS24
SB24	DB24

**Table 2: "L" Dimension**

Specify in inches. See table on page 27 for codes.

**Table 3: Terminal Heads**

Code	Description
A	1/2" NPT Conduit, Aluminum Head
B	3/4" NPT Conduit, Aluminum Head
C	1/2" NPT Conduit, Cast Iron Head
D	3/4" NPT Conduit, Cast Iron Head
P	Specify Conduit, Grey Delrin Head
W	Specify Conduit, White Polypropylene Head
Z	Specify Conduit, Explosion Proof Aluminum Head

**Table 4: Flange Option**

Code	Description
0	No Flange
F	Split Flange

**Part Number Sequence**

PSC1-SR24-600-AF

PSC1	-	SR24	-	600	-	A	F
PSC1		Table 1		Table 2		Table 3	Table 4
Sensor Type & Style No.		Thermocouple Type		"L" Dimension		Terminal Head	Flange Option



*closing the loop on thermal solutions*

# Industrial Process Thermocouples

## THERMOCOUPLE TECHNICAL DATA - WIRE CODE STANDARDS

Color-codes have been adopted by various national and international standard agencies for identification of thermocouple wire and thermocouple products. In the United States, thermocouple grade wire normally has a brown overall jacket. For Types B, R, and S the color-codes relate to the compensating cable normally used.

Type	United States ANSI 96.1	United Kingdom BS 1843	Germany 43714	France NF C42-323	Japan JIS C1610-1981
E	Purple + Purple - Red	Brown + Brown - Blue	Black + Red - Black		Purple + Red - White
J	Black + White - Red	Black + Yellow - Blue	Blue + Red - Blue	Black + Yellow - Black	Yellow + Red - White
K	Yellow + Yellow - Red	Red + Brown - Blue	Green + Red - Green	Yellow + Yellow - Purple	Blue + Red - White
N	Orange + Orange - Red				
B	Grey + Grey - Red		Grey + Red - Grey		Grey + Red - White
R	Green + Black - Red	Green + White - Blue			Black + Red - White
S	Green + Black - Red	Green + White - Blue	White + Red - White	Green + Yellow - Green	Black + Red - White
T	Blue + Blue - Red	Blue + White - Blue	Brown + Red - Brown	Blue + Yellow - Blue	Brown + Red - White



closing the loop on thermal solutions

# Industrial Process Thermocouples

## THERMOCOUPLE TECHNICAL DATA MATERIAL SELECTION GUIDE FOR THERMOWELL APPLICATIONS

Chemical	Temp. °F	Concentration %	Recommended Material	Chemical	Temp. °F	Concentration %	Recommended Material
Acetic Acid	212	All	Monel, 430 SS	Chloroacetic Acid	212	All	Hastelloy - C
Acetic Anhydride	300	-	Nickel, Monel	Chloroform, Dry	212	-	Monel
Acetone	212	All	304 SS	Chromic Acid	212	50	Hastelloy - C, 316 SS
Acetylene	400	All	304 SS, Monel, Nickel	Cider	212	All	304 SS
Alcohols (Methyl, Ethyl)	212	All	304 SS	Citric Acid	212	All	Hastelloy - C, 316 SS
Aluminum (Potassium or Sodium)	300	All	Hastelloy - C	Coal Tar	212	-	304 SS
Aluminum Acetate	-	Sat.	304 SS	Copper (10) Chloride	212	All	Hastelloy - C
Aluminum Chloride	212	All	Hastelloy - B	Copper (10) Nitrate	300	All	316 SS
Aluminum Sulfate	212	All	316 SS	Copper (10) Sulfate	300	All	316 SS
Ammonia, Dry	212	All	304 SS, 316 SS	Copper Plating Solution (Cyanide)	180	-	304 SS
Ammonium Hydroxide (Ammonia, Aqua)	212	All	304 SS, 316 SS	Copper Plating Solution (Acid)	75	-	304 SS
Ammonium Chloride	300	50	Monel	Corn Oil	300	-	304 SS
Ammonium Nitrate	300	All	304 SS	Cottonseed Oil	300	-	304 SS
Ammonium Sulfate	212	All	316 SS	Creosote, Crude	200	All	304 SS, Monel
Amyl Acetate	300	All	304 SS, Monel	Crude Oil	300	-	Monel
Aniline	75	All	Monel	Ethyl Acetate	300	All	Monel
Asphalt	250	All	304 SS	Ethyl Chloride, Dry	500	-	Steel
Barium Compound	70	All	Hastelloy - C	Ethylene Glycol	212	All	Steel
Beer	70	-	304 SS	Ethylene Oxide	75	-	Steel
Benzene (Benzol)	212	-	Steel (C1018)	Fatty Acids	500	All	316 SS
Benzine	-	-	Steel (C1018)	Ferric Chloride	75	All	Hastelloy - C, Tantalum
Benoic Acid	212	All	316 SS	Ferric Sulfate	70	All	304 SS
Bleaching Powder	70	20	Monel	Formaldehyde	212	All	316 SS
Borax	212	All	Brass	Formic Acid	150	All	316 SS
Bordeaux Mixture	200	-	304 SS	Freon	-	-	Steel
Boric Acid	212	All	316 SS	Fluorine, Anhydrous	100	-	304 SS
Bromine	125	Dry	Monel, Tantalum	Furfural	450	-	316 SS
Butabien	-	All	Brass, 304 SS	Gallic Acid	150	5	Monel
Butane	70	All	Steel, 304 SS	Gasoline	70	-	Steel, 304 SS
Butyl Alcohol	212	All	304 SS	Glucose	300	All	304 SS
Butyric Acid	70	5	Hastelloy - C, 304 SS	Glue pH 6-8	300	All	304 SS
Calcium Bisulphite	75	All	Hastelloy - C, 316 SS	Glycerin	212	All	Brass, 304 SS
Calcium Chloride	212	All	Hastelloy - C, 304 SS	Glycerol	-	-	Brass, 304 SS
Calcium Hydroxide	212	50	Hastelloy - C, 317 SS	Hydrobromic Acid	212	All	Hastelloy - B
Calcium Hypochlorite	70	20	Monel	Hydrochloric Acid (37-38%)	225	All	Hastelloy - B
Carbolic Acid	212	All	316 SS	Hydrogen Chloride, Dry	300	-	304 SS
Carbon Dioxide, Dry	212	All	Brass, Steel (C1018)	Hydrocyanic Acid	212	All	316 SS
Carbonated Water	212	All	304 SS	Hydrofluoric Acid	212	60	Monel, Hastelloy - C
Carbonated Beverages	212	All	304 SS	Hydrogen Fluoride, Dry	175	-	Steel
Carbon Disulfide	200	-	304 SS	Hydrofluogilicic Acid	212	40	Monel
Carbon Tetrachloride	70	All	Monel	Hydrogen Peroxide	212	10-100	316 SS
Chlorine, Dry	-	100	Monel	Iodine	70	All	Tantalum
Chlorine, Moist	212	All	Hastelloy - C	Kerosene	70	-	Steel, 304 SS

Sensors



closing the loop on thermal solutions

# Industrial Process Thermocouples

## THERMOCOUPLE TECHNICAL DATA

### MATERIAL SELECTION GUIDE FOR THERMOWELL APPLICATIONS

Chemical	Temp. °F	Concentration %	Recommended Material
Lacquers & Thinners	300	All	Monel
Lactic Acid	212	All	316 SS, Tantalum
Lime	212	All	316 SS
Linseed Oil	75	-	Steel, 304 SS
Magnesium Chloride	212	50	Nickel
Magnesium Hydroxide	75	All	304 SS
Magnesium Sulfate	212	50	Nickel
Malic Acid	212	All	316 SS
Mercuric Chloride	212	50	Nickel
Mercury	-	-	Steel, 304 SS
Methane	70	All	Steel
Methylene Chloride	212	All	304 SS
Methyl Chloride, Dry	75	-	Steel
Milk, Fresh or Sour	180	-	304 SS, Nickel
Molasses	300	All	304 SS
Natural Gas	70	-	304 SS
Nitric Acid	75	All	304 SS
Nitric Acid	300	All	316 SS, Tantalum
Nitrobenzene	70	-	304 SS
Oxygen	70	All	Steel
Oleic Acid	500	All	316 SS
Oxalic Acid	212	All	Monel
Palmitic Acid	500	All	316 SS
Photographic Bleaching	100	All	304 SS
Phosphoric Acid	212	All	316 SS
Phenol	-	All	316 SS
Potassium Compounds	See Sodium Compounds		
Propane	70	All	Steel
Rosin	700	100	316 SS
Sea Water	212	-	Monel
Soap & Detergents	212	All	304 SS
Sodium Bicarbonate	212	20	316 SS
Sodium Bisulphite	212	20	304 SS
Sodium Bisulfate	212	20	304 SS
Sodium Carbonate	212	40	316 SS
Sodium Chloride	300	30	Monel
Sodium Chromate	212	All	316 SS
Sodium Cyanide	212	All	304 SS
Sodium Hydroxide	212	30	316 SS
Sodium Hypochlorite	75	10	Hastelloy - C
Sodium Nitrate	212	40	304 SS
Sodium Nitrate	75	20	316 SS
Sodium Phosphate	212	10	Steel
Sodium Silicate	212	10	Steel
Sodium Sulfate	212	30	316 SS
Sodium Sulfide	212	10	316 SS
Sodium Sulfite	212	30	304 SS

Chemical	Temp. °F	Concentration %	Recommended Material
Sodium Thiosulfate	212	All	304 SS
Steam	-	-	304 SS
Stearic Acid	500	All	316 SS
Sugar Solutions	300	All	304 SS
Sulfur	500	-	304 SS
Sulfur Chloride, Dry	75	-	316 SS
Sulfur Dioxide, Dry	500	-	316 SS
Sulfur Trioxide, Dye	500	-	316 SS
Sulfuric Acid	212	5	Hastelloy - B
Sulfuric Acid	212	5-100	Hastelloy - B, Hastelloy - D
Sulfuric Acid, Fuming	175	-	Hastelloy - C
Sulfurous Acid	75	20	316 SS
Titanium Tetrachloride	75	All	316 SS
Tannic Acid	75	40	Hastelloy - B
Toluene	75	-	Steel
Trichloroacetic Acid	75	All	Hastelloy - B
Trichlorethylene	-	-	Steel (C1018)
Turpentine	75	All	316 SS
Varnish	150	-	Steel, 304 SS
Vinegar	212	All	Monel, 304 SS
Zinc Chloride	212	All	Hastelloy - B
Zinc Sulfate	212	All	316 SS

## INTRODUCTION

Durex offers a complete line of thermocouples that are specifically designed for the plastics processing industry. These thermocouples are typically ANSI type J or K calibration and consist of a flexible thermocouple conductor insulated with fiberglass. Designs utilize factory standard bayonet fittings or threaded fittings that retrofit most plastic processing equipment that is currently on the market. Durex also offers European and Japanese retrofit parts with equivalent color codes for direct replacement in these machines.

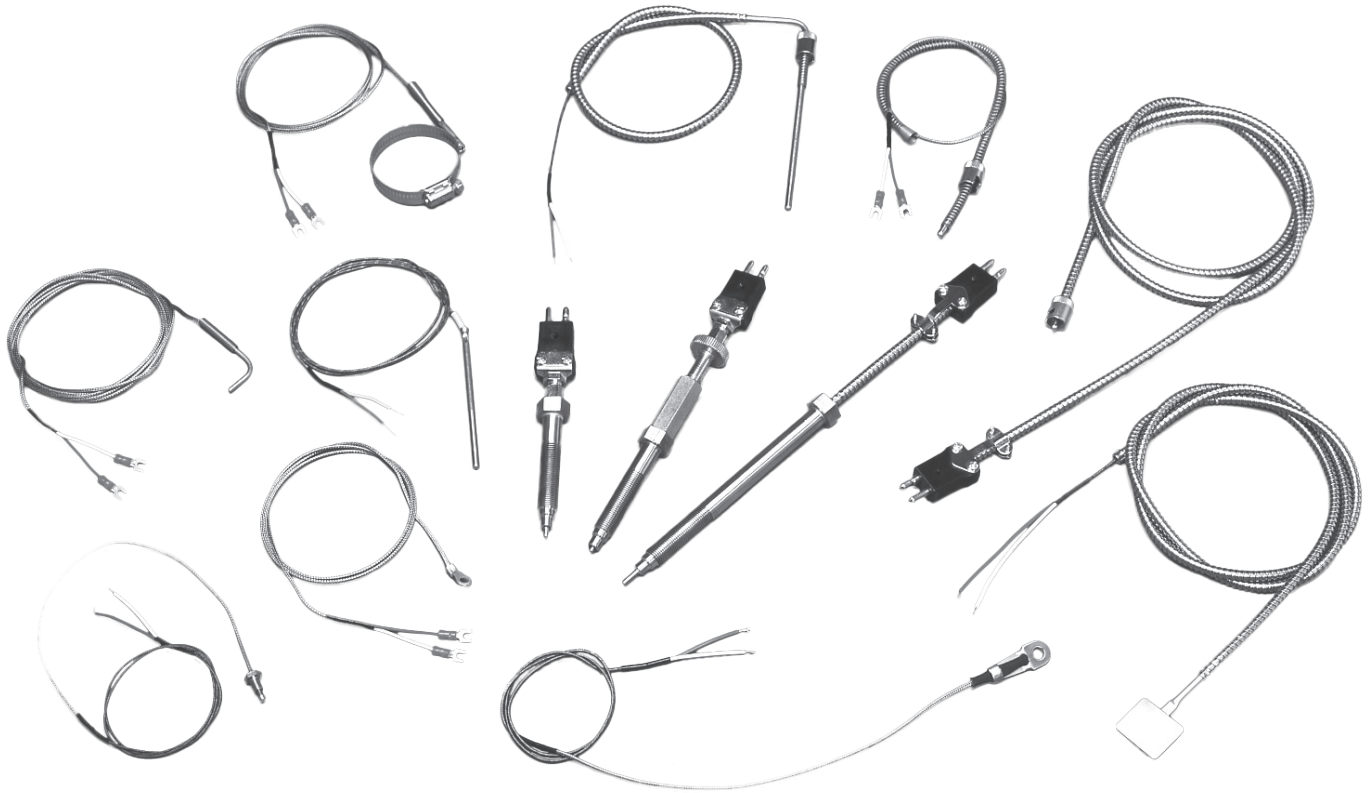

### **Design Features:**

- Typical terminations: split leads, spade lugs, or polarized male plugs
- Adjustable to various immersion depths
- Provide fast response times
- Wide variety of sizes and styles
- Custom designs available
- Dependable temperature measurement
- Economical general purpose thermocouples

### **Typical Applications:**

- Extrusion
- Injection Molding
- Blow Molding
- Hot Runner Systems
- Thermoforming
- Custom Die Applications

## CODE DEFINITIONS AND TERMINATION TYPES

### Thermocouple Type

Thermocouple Type Codes				Limits of Error
E	J	K	T	Standard Limits
2	3	4	8	Special Limits

### Sheath Diameter

Code	Diameters
B	.125" or 1/8" O.D.
V	.156" or 5/32" O.D.
C	.188" or 3/16" O.D.
D	.250" or 1/4" O.D.
F	.375" or 3/8" O.D.

### Junction Type

Code	Single Junction
G	Grounded
U	Ungrounded

### Code Definitions

"L" Dimensions				"B" Dimensions				"A" Dimensions		Fractional Dimension Letter Code					
"L" dimensions are specified in whole inches and a single alpha character which represents a fraction. Enter the three digit code as follows:				"B" dimensions are specified in fractions from 1/8" to 1". Use the single alpha character to indicate the tip length. Enter the code as follows:				"A" dimensions are specified in whole inches only. Enter the three digit code as follows:		1/16"	A	11/16"	L	No Fraction	
										1/8"	B	3/4"	M		
3"	030	10 5/8"	10K	3/16"	C	13/16"	N	1/4"	D	7/8"	P				
4 1/2"	04H	12"	120	5/16"	E	15/16"	R	9"	009	3/8"	F	1"	S		
6 1/4"	06D	15 3/8"	15F	1/8"	B	5/8"	K	12"	012	7/16"	G	0	No		
7 7/8"	07P	17 3/4"	17M	1/4"	D	3/4"	M	36"	036	1/2"	H	Fraction			
9 5/8"	09K	22 1/8"	22B	3/8"	F	7/8"	P	144"	144	9/16"	J				
				1/2"	H	1"	S			5/8"	K				

### Termination Type Numbers

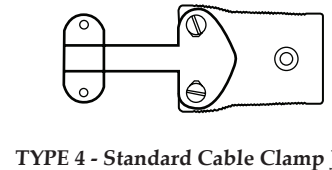
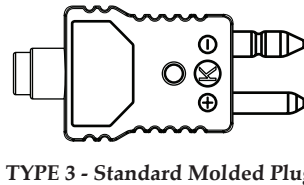
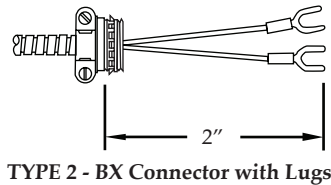
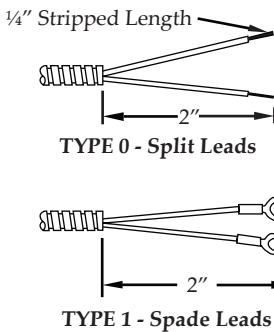

## ADJUSTABLE DEPTH THERMOCOUPLE WITH SPRING

The TBA10 thermocouple uses a compression spring and bayonet lockcap which allows this design to adjust to hole depths up to 12" deep. This design also features a stainless steel tip with a silver solder junction for fast response. A tig welded junction is available upon request.

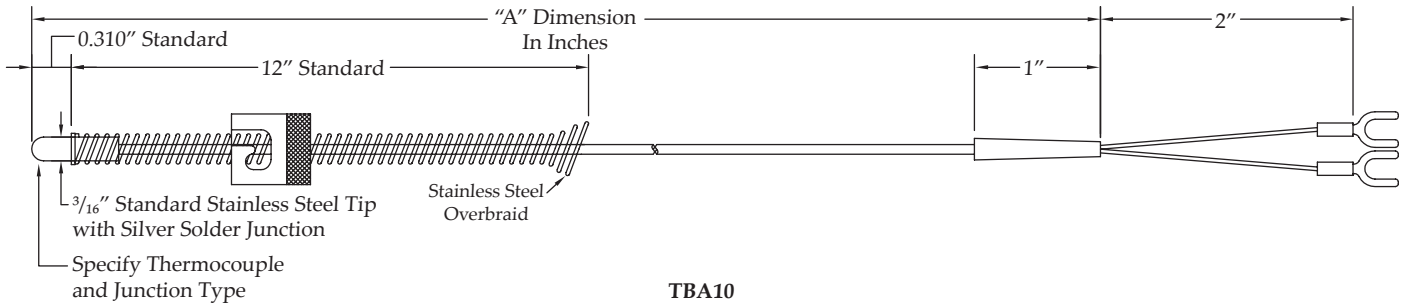

## ADJUSTABLE DEPTH THERMOCOUPLE WITH ARMOR

The TBA20 thermocouple uses flexible stainless steel armor cable with a rotating bayonet lockcap on the outside diameter that adjusts to various immersion depths. The armor cable assures maximum protection of the thermocouple element for extension from the process.

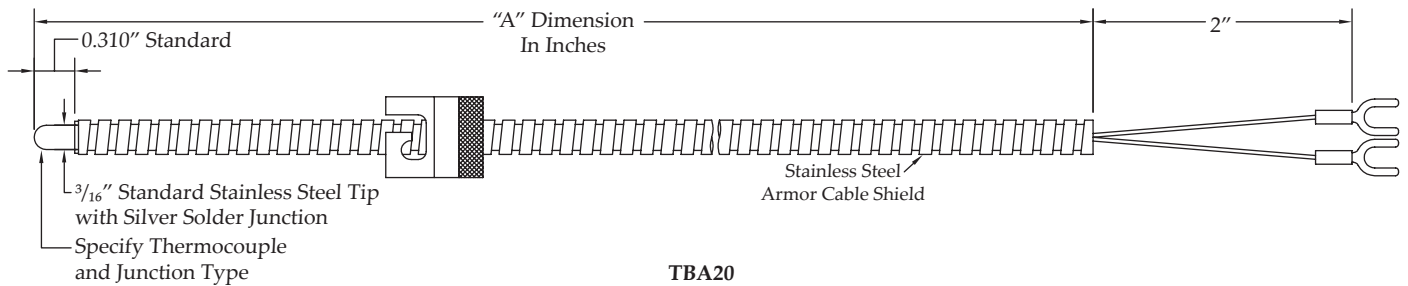

<b>Part Number Sequence</b>					TBA10-JG-0360	See tables on page 54
TBA10	-	J	G	-	036	0
Sensor Type & Style No.		Thermocouple Type	Junction Type		"A" Dimension	Termination Number

Sensors

## MELT BOLT THERMOCOUPLE

Durex melt bolts are designed for dependable temperature measurement of the plastic melt stream within extruders and injection molding equipment. Standard assemblies are supplied with mineral insulated sensing elements for extended pressure and temperature performance. Optional thermal barriers of Teflon® (500°F) and Mycalex® (900°F) are available upon request.

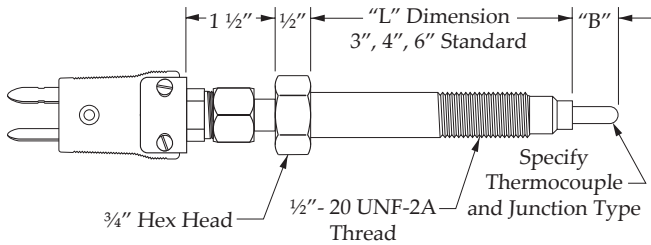

TPM0 - Melt Bolt with Standard Plug

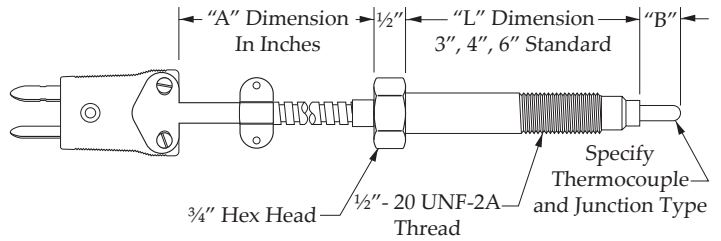

TPM1 - Melt Bolt with Standard Plug on Stainless Steel Armor

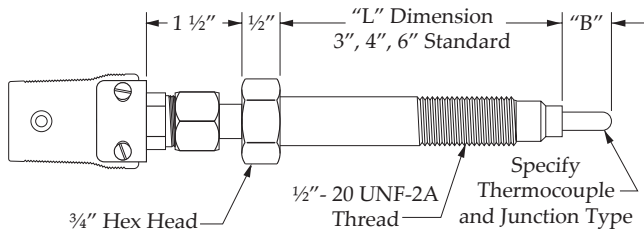

TPM2 - Melt Bolt with Standard Jack

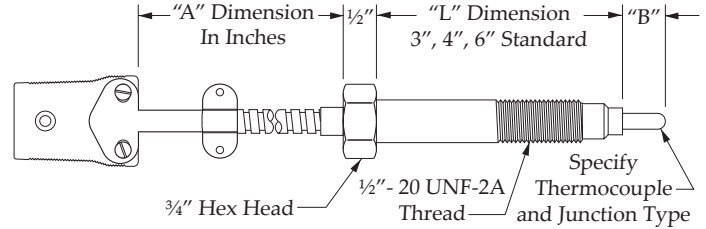

TPM3 - Melt Bolt with Standard Jack on Stainless Steel Armor

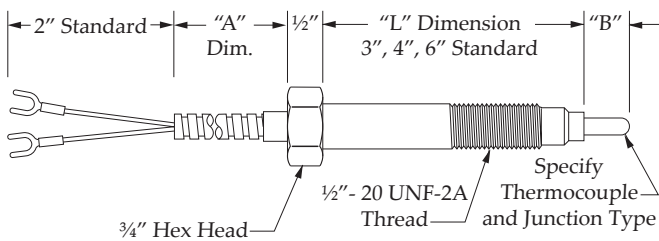

TPM4 - #6 Spade Lugs with Stainless Steel Armor

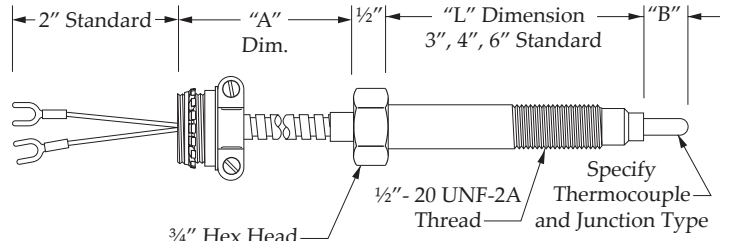

TPM5 - #6 Spade Lugs with BX Connector on Stainless Steel Armor

### Part Number Sequence

TPM4-JG-030-P012

See tables on page 54

TPM4	-	J	G	-	030	-	P = 7/8"	012
Sensor Type & Style No.		Thermocouple Type	Junction Type		"L" Dimension		"B" Dimension	"A" Dimension

### BLANK BOLTS

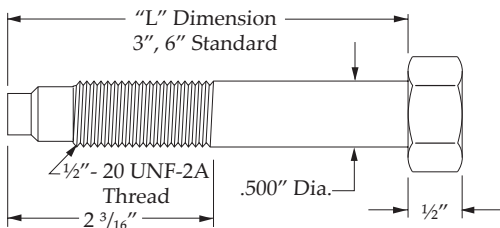

Catalog Number	"L" Dimension
244008	3"
244009	6"

Blank bolt occupies hole when melt bolt is removed.



## FIXED BAYONET THERMOCOUPLES

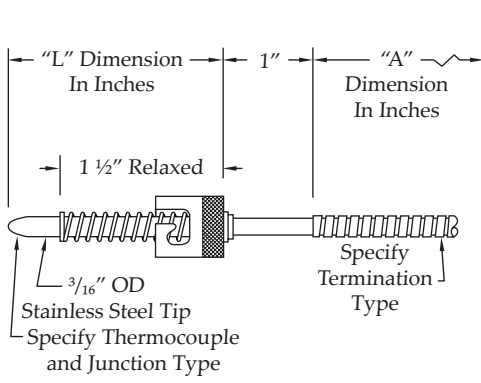

TBF00 - Straight Run Thermocouple

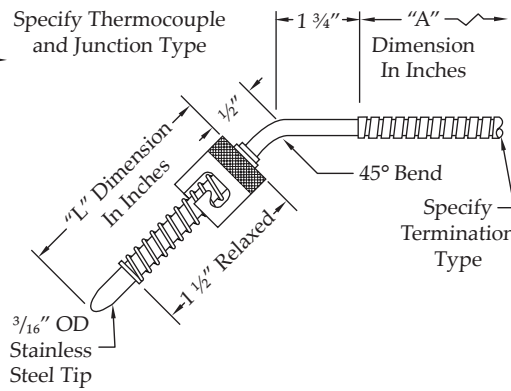

TBF45 - 45° Bend Thermocouple

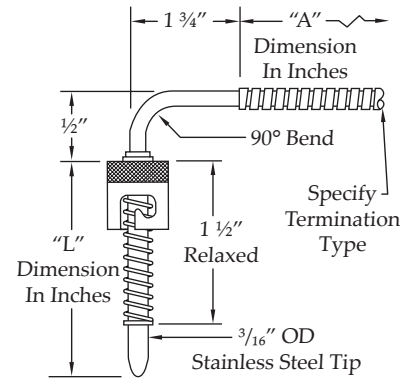

TBF90 - 90° Bend Thermocouple

### Part Number Sequence

TBF45-JG-060-0241 See tables on page 54

TBF45	-	J	G	-	060	-	024	1
Sensor Type & Style No.		Thermocouple Type	Junction Type		"L" Dimension		"A" Dimension	Termination Type

## COMPRESSION FITTING THERMOCOUPLE

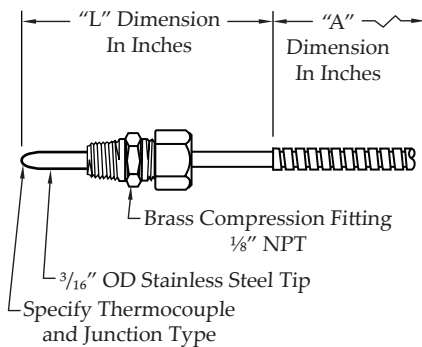

TCF00 - Straight Run Thermocouple

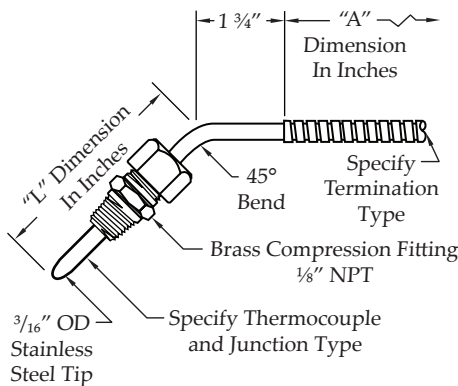

TCF45 - 45° Bend Thermocouple

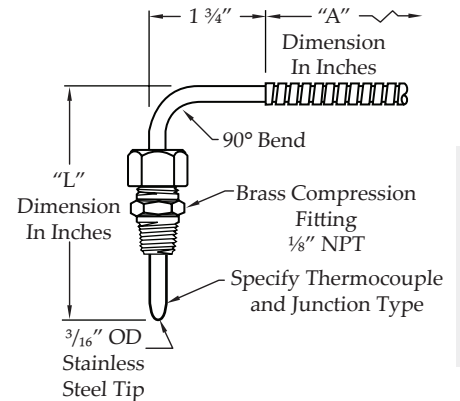

TCF90 - 90° Bend Thermocouple

### Part Number Sequence

TCF00-JG-030-0361 See tables on page 54

TCF00	-	J	G	-	030	-	036	1
Sensor Type & Style No.		Thermocouple Type	Junction Type		"L" Dimension		"A" Dimension	Termination Type

## ADJUSTABLE MELT BOLT THERMOCOUPLES

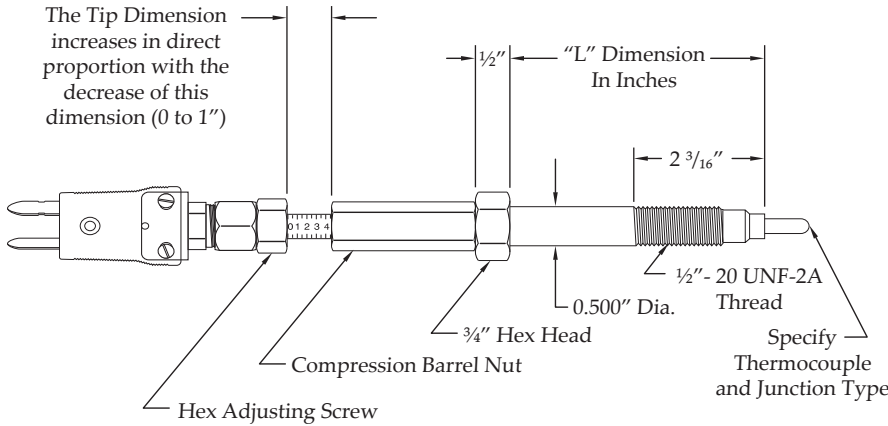

TAM1 - Adjustable Tip Melt Bolt

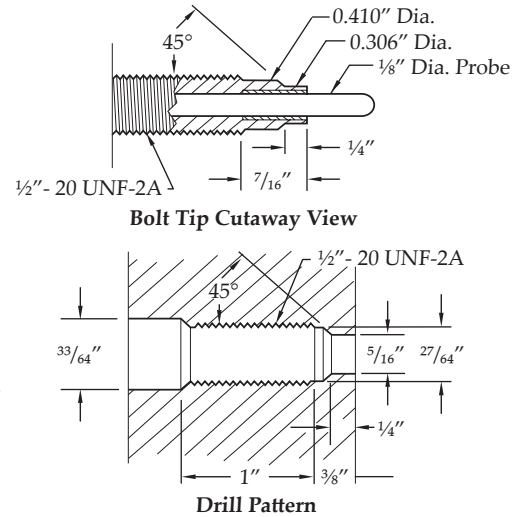

The standard assembly consists of an 1/8" Outer Diameter MgO insulated type "J" thermocouple in a stainless steel sheath. The body is stainless steel with a 1/2" - 20 UNF-2A thread. A thermal barrier reduces heat transfer from body to thermocouple. Other parts include a packing seal, compression barrel nut, hex adjusting screw, and a polarized quick-disconnect male plug. Standard immersion is adjustable from flush to 1". Standard body lengths are 3", 4", and 6" measured from the beginning of wrench flats to the bolt tip. The adjustable plastic melt thermocouple has a movable probe activated by an inner screw mechanism. The probe can be immersed into or withdrawn from the plastic melt stream while the extruder eliminates thermocouple breakage at start-up and prevents hang-up. The thermocouple is self-cleaning; as it is retracted into the body any film formed on it is scraped off.

<b>Part Number Sequence</b>					TAM1-JG-040	See tables on page 54
TAM1	-	J	G	-	040	
Sensor Type & Style No.		Thermocouple Type	Junction Type		"L" Dimension (3, 4, 6" are Standard)	

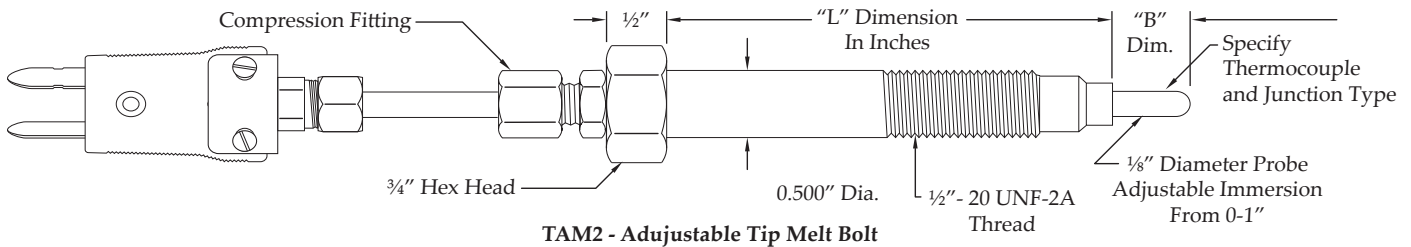

TAM2 - Adjustable Tip Melt Bolt

The TAM2 adjustable melt thermocouple features an all stainless steel construction and uses a compression fitting as the mechanism for the adjustment. The TAM2 allows for easy and economical replacement of the mineral insulated thermocouple element.

<b>Part Number Sequence</b>							TAM2-JG-040 - M	See tables on page 54
TAM2	-	J	G	-	040	-	M = 3/4"	
Sensor Type & Style No.		Thermocouple Type	Junction Type		"L" Dimension (3, 4, 6" are Standard)		"B" Dimension	

## SURFACE MOUNT THERMOCOUPLES

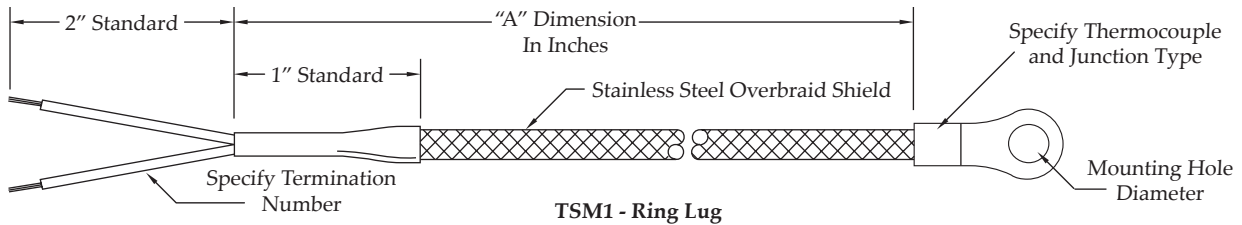

**TSM1 - Ring Lug**

Leadwire Conductor is Stranded with Fiberglass Insulation and Stainless Steel Overbraid Shield

### Termination Options

Termination Number	Description
0	2" Split Leads
1	#6 Spade Lugs
3	Standard Plug
4	Standard Jack
X	Special, Specify

### Mounting Hole Options

Mounting Hole Type	Stud Size	Hole Diameter
A	No. 6	.144"
B	No. 8	.169"
C	No. 10	.196"
D	1/4"	.266"
E	3/8"	.390"

### Part Number Sequence

TSM1-JG-0240C

See tables on page 54

TSM1	-	J	G	-	024	0	C
Sensor Type & Style No.		Thermocouple Type	Junction Type		"A" Dimension	Termination Option	Mounting Hole Diameter

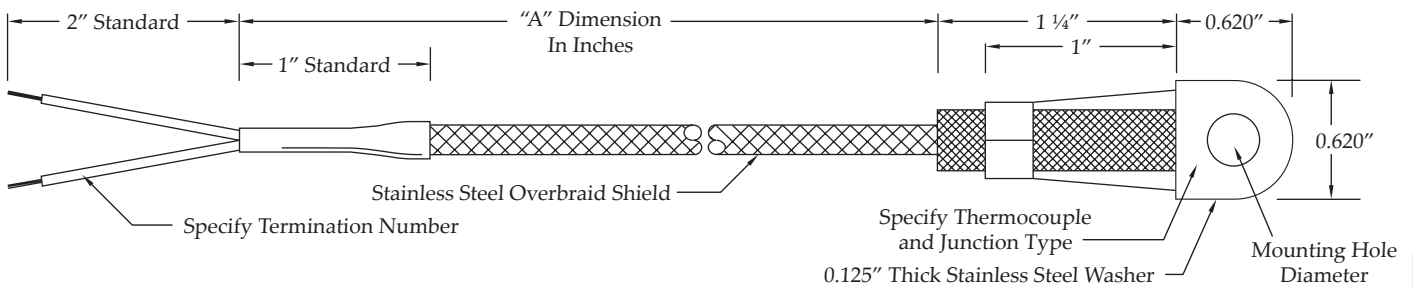

**TSM2 - Gasket with Bracket**

Leadwire Conductor is Stranded with Fiberglass Insulation and Stainless Steel Overbraid Shield

### Termination Options

Termination Number	Description
0	2" Split Leads
1	#6 Spade Lugs
3	Standard Plug
4	Standard Jack
X	Special, Specify

### Mounting Hole Options

Mounting Hole Type	Stud Size	Hole Diameter
A	1/4"	9/32"
B	5/16"	11/32"
C	3/8"	13/32"
D	7/16"	15/32"
E	1/2"	17/32"

### Part Number Sequence

TSM2-JG-0180B

See tables on page 54

TSM2	-	J	G	-	018	0	B
Sensor Type & Style No.		Thermocouple Type	Junction Type		"A" Dimension	Termination Option	Mounting Hole Diameter

## SURFACE MOUNT THERMOCOUPLES

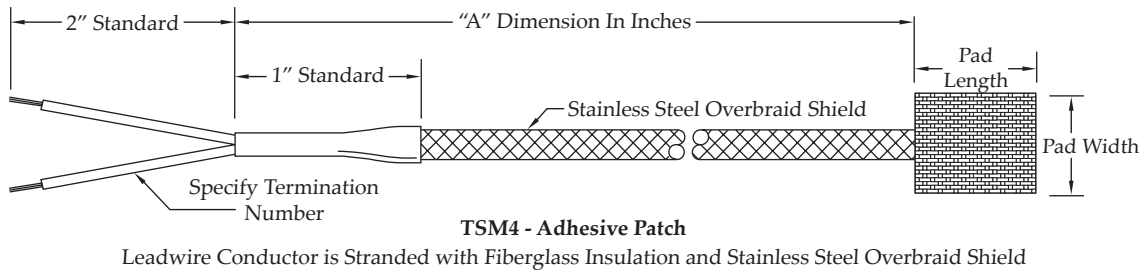
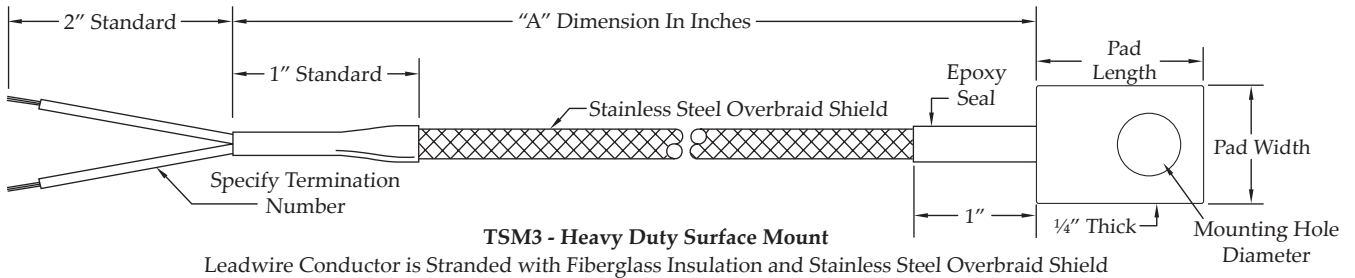

### Pad Material

Code	Description
B	Brass
K	Kapton
S	Silicone Rubber

### Pad Thickness

Code	Description
D	1/4"
F	3/8"
H	1/2"

### Pad Width

Code	Description
00M	Standard 3/4"

### Pad Length

Code	Description
010	Standard 1"

### Leadwire Options

Code	Description
G	Fiberglass Stranded
H	Fiberglass/Stainless Steel Overbraid Stranded
J	Fiberglass/Stainless Steel Armor Stranded

### Termination Options

Termination Number	Description
0	2" Split Leads
1	#6 Spade Lugs
3	Standard Plug
4	Standard Jack
X	Special, Specify

### Mounting Hole Options

Mounting Hole Type	Stud Size	Hole Diameter
A	No. 6	.144"
B	No. 8	.169"
C	No. 10	.196"
D	1/4"	.266"
E	3/8"	.390"
P	Mounting Patch	

**Part Number Sequence** TSM3-JU-BA00M010-024G0C See tables on page 54

TSM3 - J U - B A 00M 010 - 024 G 0 C

Sensor Type Thermocouple Junction Pad Pad Pad Pad "A" Leadwire Termination Mounting Hole & Style No. Type Type Material Thickness Width Length Dim. Option Option Diameter/Patch

## NOZZLE THERMOCOUPLES

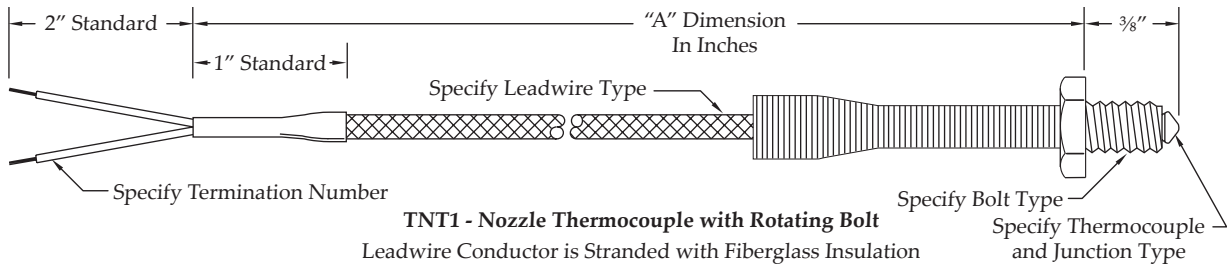

### Leadwire Type

Leadwire Number	Description
H	Stranded Fiberglass Leadwire with SS Overbraid
J	Stranded Fiberglass Leadwire with SS Armor

Standard assemblies supplied with stranded leadwire conductor. Solid conductor available upon request.

### Termination Options

Termination Number	Description
0	2" Split Leads
1	#6 Spade Lugs
3	Standard Plug
4	Standard Jack
X	Special, Specify

### Bolt Options

Bolt Type	Description
S	1/4 - 28
Y	M 6 x 1
Z	M 8 x 1.25

### Part Number Sequence

TNT1-JG-036H0Y See tables on page 54

TNT1	-	J	G	-	036	H	0	Y
Sensor Type & Style No.		Thermocouple Type	Junction Type		"A" Dimension	Leadwire Type	Termination Option	Bolt Options

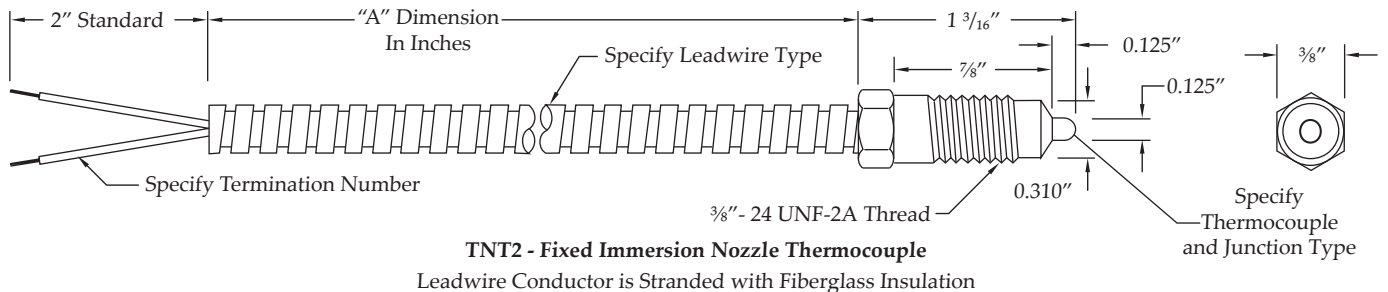

### Leadwire Type

Leadwire Number	Description
H	Stranded Fiberglass Leadwire with SS Overbraid
J	Stranded Fiberglass Leadwire with SS Armor

Standard assemblies supplied with stranded leadwire conductor. Solid conductor available upon request.

### Termination Options

Termination Number	Description
0	2" Split Leads
1	#6 Spade Lugs
3	Standard Plug
4	Standard Jack
X	Special, Specify

### Part Number Sequence

TNT2-JG-048J0Z See tables on page 54

TNT2	-	J	G	-	048	J	0	Z
Sensor Type & Style No.		Thermocouple Type	Junction Type		"A" Dimension	Leadwire Type	Termination Option	Enter Z

## NOZZLE THERMOCOUPLES

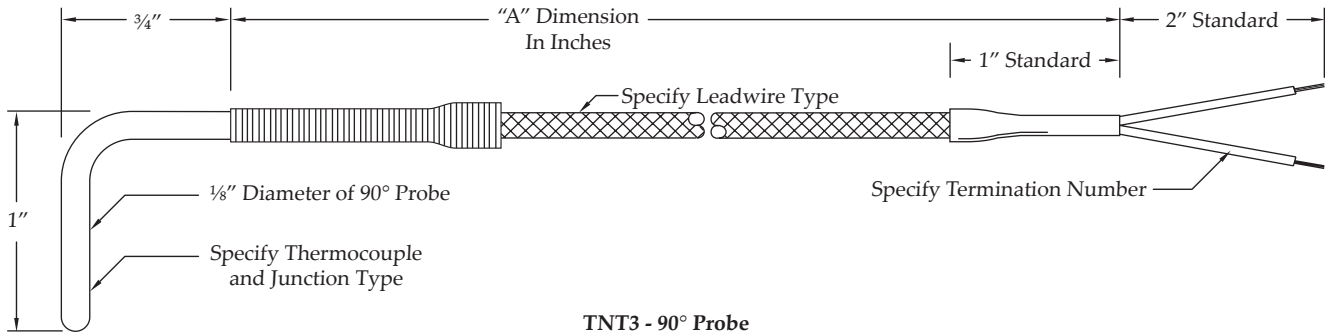

### Leadwire Type

Leadwire Number	Description
H	Stranded Fiberglass Leadwire with SS Overbraid
J	Stranded Fiberglass Leadwire with SS Armor

### Termination Options

Termination Number	Description
0	2" Split Leads
1	#6 Spade Lugs
3	Standard Plug

### Part Number Sequence

TNT3-JG-072H0Z

See tables on page 54

TNT3	-	J	G	-	072	H	0	Z
Sensor Type & Style No.		Thermocouple Type	Junction Type		"A" Dimension	Leadwire Type	Termination Option	Enter Z

## SHIM STOCK THERMOCOUPLES

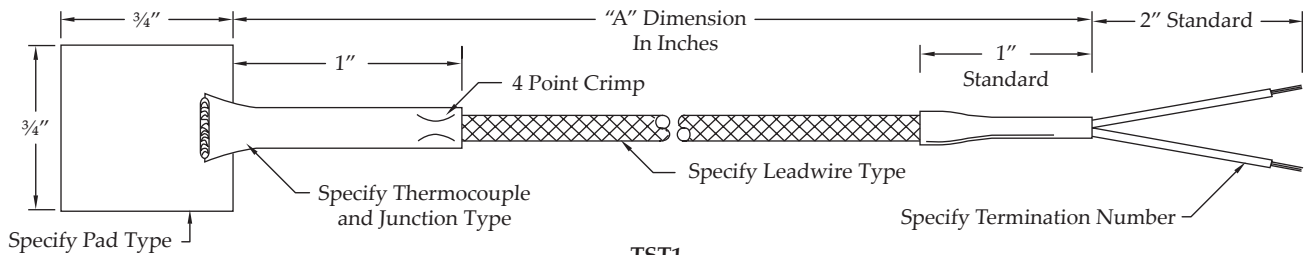

Leadwire Conductor is Stranded with Fiberglass Insulation

### Leadwire Type

Leadwire Number	Description
G	Stranded Fiberglass Leadwire with Fiberglass Jacket
H	Stranded Fiberglass Leadwire with SS Overbraid Shield
J	Stranded Fiberglass Leadwire with SS Armor Cable Shield

### Termination Options

Termination Number	Description
0	2" Split Leads
1	#6 Spade Lugs
3	Standard Plug

### Pad Options

Pad Type	Description
S	3/4" x 3/4" x .007" Thick
P	1" x 1" x .032" Thick
B	1" x 1" x .060" Thick

### Part Number Sequence

TST1-JG-036G0P

See tables on page 54

TST1	-	J	G	-	036	G	0	P
Sensor Type & Style No.		Thermocouple Type	Junction Type		"A" Dimension	Leadwire Type	Termination Option	Pad Type

## PIPE CLAMP THERMOCOUPLES

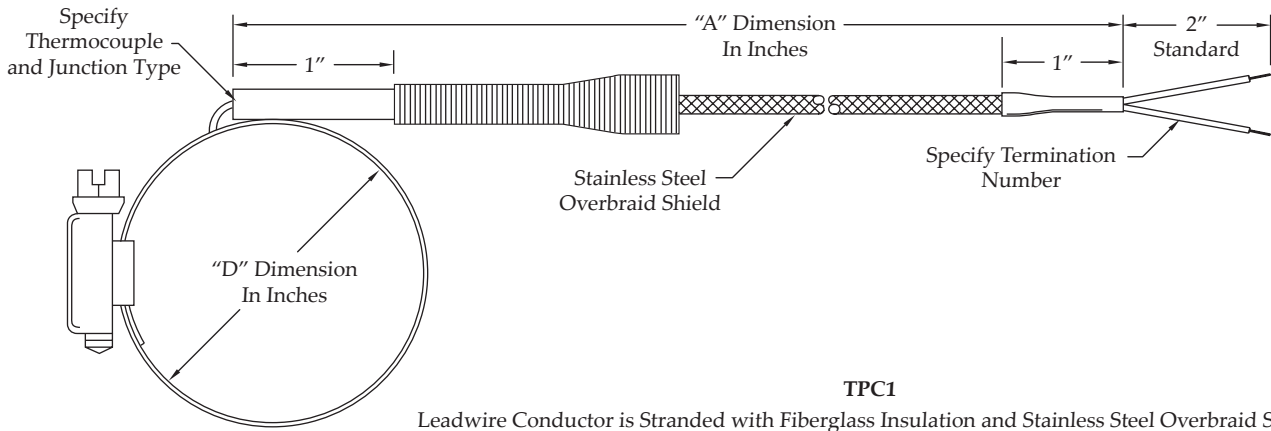

TPC1  
Leadwire Conductor is Stranded with Fiberglass Insulation and Stainless Steel Overbraid Shield

### "D" Dimension Options

"D" Dimension Number	Description
N	1/2" to 7/8"
1	7/8" to 1 1/4"
2	1 1/4" to 2 1/4"
3	2 3/4" to 3 5/16"
4	3 1/4" to 4 1/4"
5	4 1/4" to 5 1/4"

### Termination Options

Termination Number	Description
0	2" Split Leads
1	#6 Spade Lugs
3	Standard Plug

### Part Number Sequence

TPC1-JG-04230

See tables on page 54

TPC1	-	J	G	-	042	3	0
Sensor Type & Style No.		Thermocouple Type	Junction Type		"A" Dimension	"D" Dimension	Termination Option

## PIPE CLAMP ADAPTERS

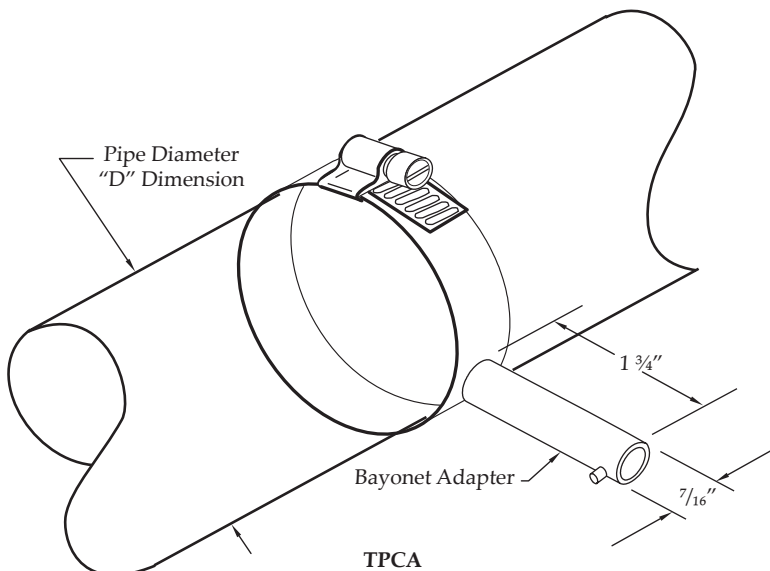

### "D" Dimension Options

"D" Dimension Number	Description
N	1/2" to 7/8"
1	7/8" to 1 1/4"
2	1 1/4" to 2 1/4"
3	2 3/4" to 3 5/16"
4	3 1/4" to 4 1/4"
5	4 1/4" to 5 1/4"

### Part Number Sequence TPCA-2

TPCA	-	2
Sensor Type & Style No.		"D" Dimension

## GENERAL PURPOSE THERMOCOUPLES

General purpose thermocouples are designed for economical use in a wide variety of applications up to 800°F. Sheath material is 304 stainless steel. Type J (Iron-Constantan) calibration is standard. Other calibrations available upon request.

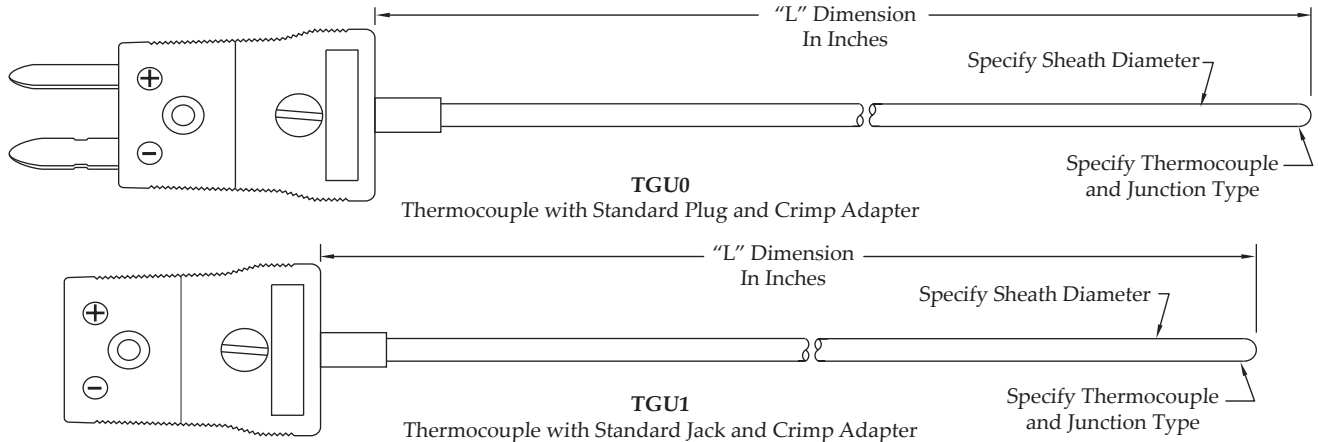

### Part Number Sequence

TGU1	-	J	G	-	C (Letter CODE)	12H
Sensor Type & Style No.		Thermocouple Type	Junction Type		Sheath Diameter	"L" Dimension

TGU1-JG-C12H See tables on page 54

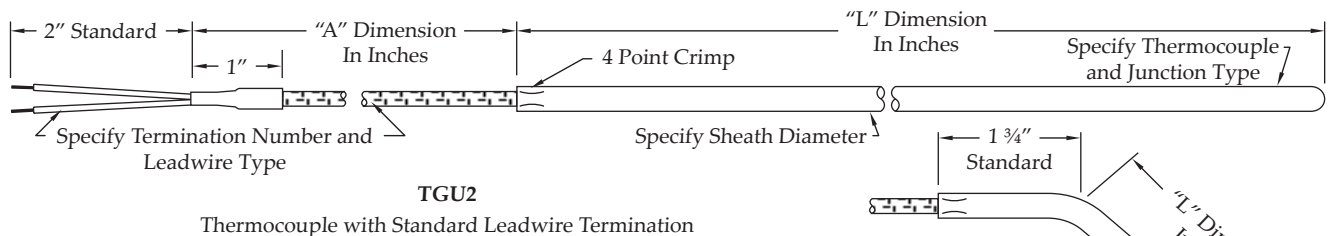

### Leadwire Type

Leadwire Number	Description
G	Fiberglass Leadwire with Overall Fiberglass Jacket
H	Stranded Fiberglass Leadwire with SS Overbraid Shield
J	Stranded Fiberglass Leadwire with SS Armor Cable Shield
K	Teflon Leadwire with Overall Teflon Jacket (400°F Max.)

### Termination Options

Termination Number	Description
0	2" Split Leads
1	#6 Spade Lugs
3	Standard Plug
4	Standard Jack

Standard assemblies supplied with stranded leadwire conductor. Solid conductor available upon request.

### Part Number Sequence

TGU2	-	J	G	-	V = .156"	18D	-	035	H	0
Sensor Type & Style No.		Thermocouple Type	Junction Type		Sheath Diameter	"L" Dimension		"A" Dimension	Leadwire Type	Termination Option

TGU2-JG-V18D-035H0 See tables on page 54



## EXTENSION ASSEMBLIES

Standard assemblies are manufactured with fiberglass insulated thermocouple wire and stainless steel armor cable protection. Standard calibration is type "J". Other calibrations and special connections are available upon request.

**TEX1** Two BX Connectors with #6 Spade Lugs

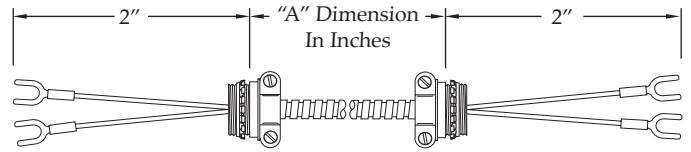

**TEX2** BX Connectors with #6 Spade Lugs and Standard Molded Plug

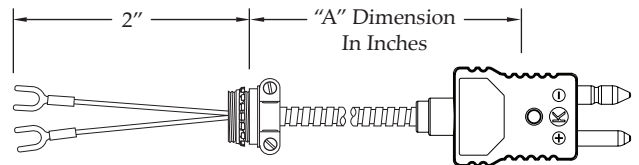

**TEX3** BX Connector with #6 Spade Lugs and Standard Jack

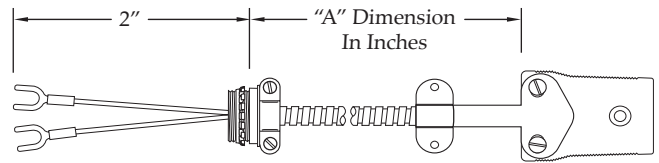

**TEX4** Standard Molded Plug and Jack

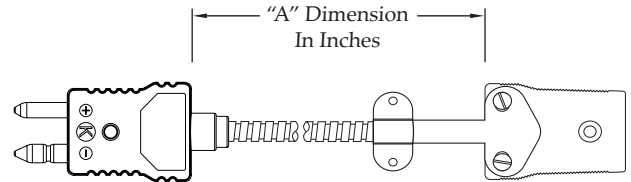

**TEX5** Two Standard Molded Plugs

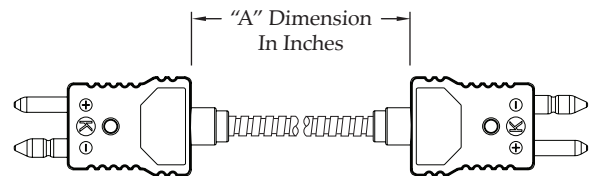

**TEX6** Two Standard Jacks

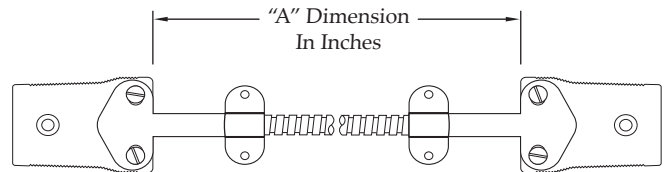

### Part Number Sequence

TEX4	-	J	-	048
Sensor Type & Style No.		Thermocouple Type		"A" Dimension

## ADJUSTABLE DEPTH RTDs

Resistance Temperature Detectors (RTDs) are continuing to expand as a temperature sensor for plastic machinery applications. All the standard plastics thermocouple designs are available in RTD configurations. The standard element is 100 ohm Platinum, 0.00385 Ω/Ω/°C, Class B per IEC 751 and DIN 43760 (± 0.1% at 0°C). All assemblies can be specified as 2, 3, or 4 wire configurations. Please specify requirements.

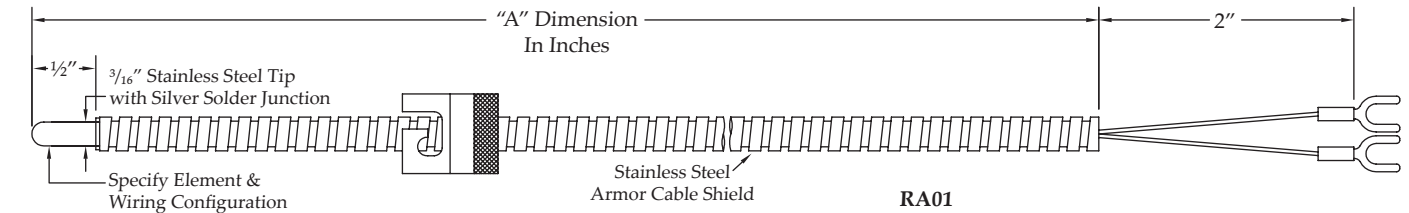
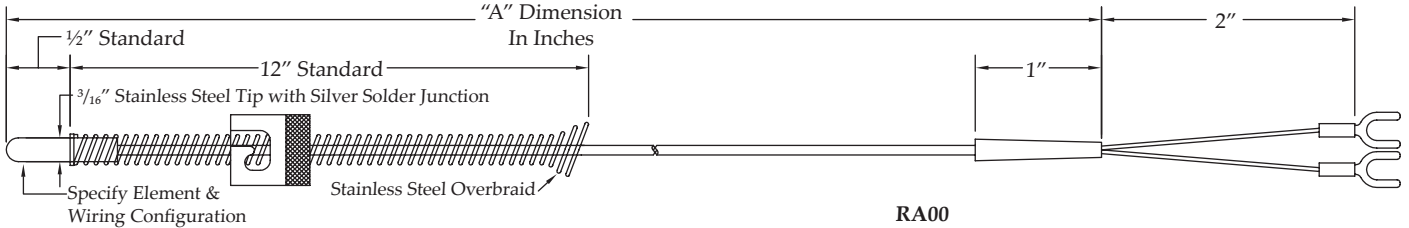

<b>Part Number Sequence</b>							
RA01	-	A	B	-	048	L	1
RA01		Next Page	Next Page		See page 54	L = 500°F / M = 900°F	Next Page
Sensor Type & Style No.		Element Type	Wiring Configuration		"A" Dimension	Operating Temperature	Termination Type

## FIXED BAYONET RTDs

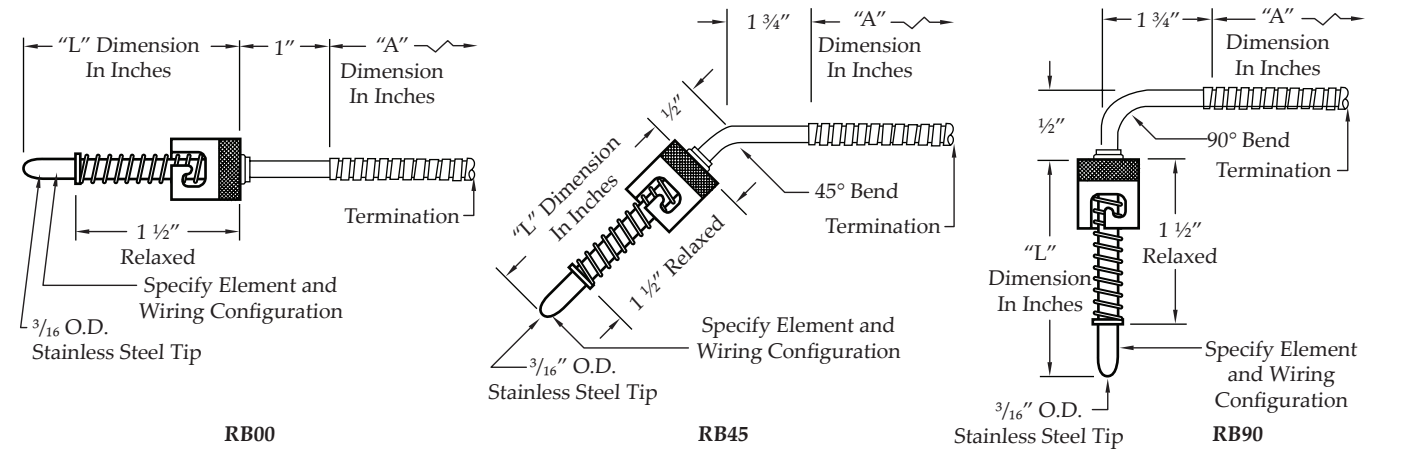

<b>Part Number Sequence</b>							
RB00	-	G	B	-	09F	L	4
RB00		Next Page	Next Page		See page 54	L = 500°F / M = 900°F	Next Page
Sensor Type & Style No.		Element Type	Wiring Configuration		"L" Dimension	Operating Temperature	Termination Type

## COMPRESSION FITTING RTDs

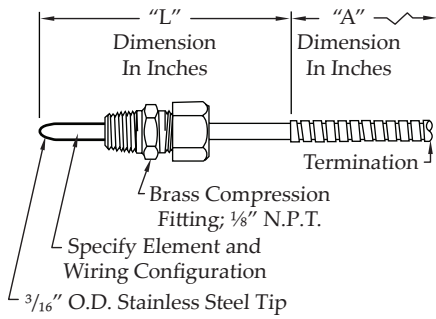

RC00

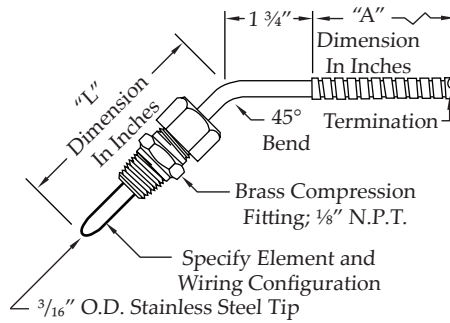

RC45

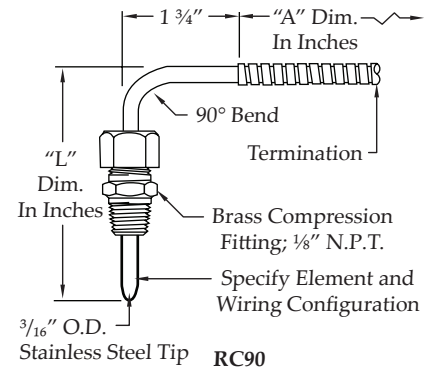

RC90

### Part Number Sequence

RC45-ED-04K-028L0

See tables on next page

RC45 - E D - 04K 028 - L 0

RC45 Table Below Table Below See page 54 See page 54 L = 500°F / M = 900°F Options Below

Sensor Type & Style No.	Element Type	Wiring Configuration	"L" Dimension	"A" Dimension	Operating Temperature	Termination Type
-------------------------	--------------	----------------------	---------------	---------------	-----------------------	------------------

## RTD OPTIONS

Code	Element Type
A	100 ohm Platinum, Class B .00385 Coefficient
B	100 ohm Platinum, Class A .00385 Coefficient
E	1000 ohm Platinum, Class B .00385 Coefficient
G	100 ohm Platinum, Class B .00392 Coefficient

Code	Wiring
A	Single, 2 Wire
B	Single, 3 Wire
C	Single, 4 Wire
D	Double, 4 Wire

## TERMINATION OPTIONS

1/4" Stripped Length

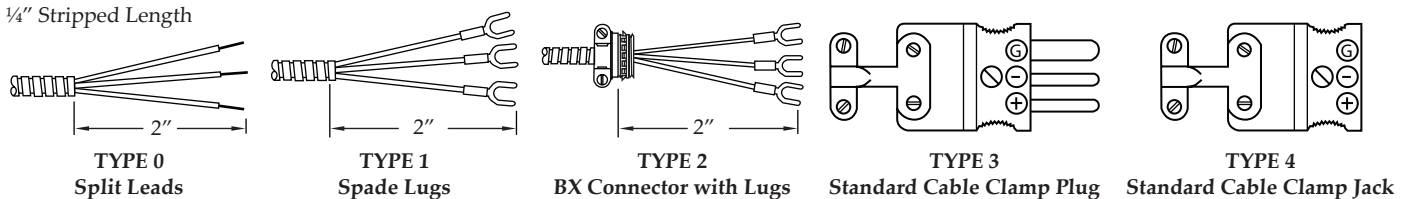



*closing the loop on thermal solutions*

# Accessories

## INTRODUCTION

All the "extras" needed to complete your thermal processing installation are available from Durex. A comprehensive line of sensor accessories are stocked and ready for immediate shipping.





closing the loop on thermal solutions

## INSULATED THERMOCOUPLE WIRE

### TYPE "J" THERMOCOUPLE WIRE

ANSI Color Code: Positive - White, Negative - Red, Overall - Brown

Insulation	Insulation Temperature Rating	Gauge	Part Number	Limits of Error	Solid / Stranded
Flexible PVC Plastic, Duplex Parallel, "Ripcord" Peelable Construction	221°F (105°C)	24	LJD-24-SL-PVC-RIP	Standard	Solid
		24	LJS-24-SL-PVC-RIP	Special	Solid
Extruded Flexible Teflon® FEP Plastic, Duplex Parallel, Extruded FEP Jacket	400°F (204°C)	20	LJD-20-SL-FEP-FEP	Standard	Solid
		20	LJS-20-SL-FEP-FEP	Special	Solid
		20	LJD-20-ST-FEP-FEP	Standard	Stranded
		24	LJD-24-SL-FEP-FEP	Standard	Solid
		24	LJS-24-SL-FEP-FEP	Special	Solid
		24	LJD-24-ST-FEP-FEP	Standard	Stranded
Fused TFE Tape, Duplex Parallel, TFE Tape Jacket	500°F (260°C)	20	LJD-20-SL-TFE-TFE	Standard	Solid
		20	LJS-20-SL-TFE-TFE	Special	Solid
		24	LJD-24-SL-TFE-TFE	Standard	Solid
		24	LJS-24-SL-TFE-TFE	Special	Solid
Polyimide Fused Tape, Duplex Parallel, Polyimide Fused Tape Jacket	600°F (315°C)	20	LJD-20-SL-KAP-KAP	Standard	Solid
		20	LJD-20-ST-KAP-KAP	Standard	Stranded
		20	LJS-20-SL-KAP-KAP	Special	Solid
		24	LJD-24-ST-KAP-KAP	Standard	Stranded
Polyimide Fused Tape, Twisted Pair, No Jacket	600°F (315°C)	24	LJS-24-SL-KAP-TW	Special	Solid
Fiberglass Wrap, Duplex Parallel, Fiberglass Braided Jacket	900°F (480°C)	28	LJD-28-SL-FGW-FBG	Standard	Solid
		28	LJS-28-SL-FGW-FBG	Special	Solid
		30	LJD-30-SL-FGW-FBG	Standard	Solid
		30	LJS-30-SL-FGW-FBG	Special	Solid
Fiberglass Braid, Duplex Parallel, Fiberglass Braid Jacket	900°F (480°C)	20	LJD-20-SL-FBG-FBG	Standard	Solid
		20	LJS-20-SL-FBG-FBG	Special	Solid
		20	LJD-20-ST-FBG-FBG	Standard	Stranded
		22	LJD-22-ST-FBG-FBG	Standard	Stranded
		24	LJD-24-SL-FBG-FBG	Standard	Solid
		24	LJS-24-SL-FBG-FBG	Special	Solid
		24	LJD-24-ST-FBG-FBG	Standard	Stranded
Fiberglass Braid, Duplex Parallel, Fiberglass Braid Jacket, Stainless Steel Overbraid	900°F (480°C)	20	LJD-20-SL-FBG-SSB	Standard	Solid
		20	LJD-20-ST-FBG-SSB	Standard	Stranded
		22	LJD-22-ST-FBG-SSB	Standard	Stranded
High Temperature Glass Braid, Duplex Parallel, High Temperature Glass Braid Jacket	1300°F (705°C)	20	LJD-20-SL-FBH-FBG	Standard	Solid
		20	LJS-20-SL-FBH-FBG	Special	Solid



*closing the loop on thermal solutions*

## INSULATED THERMOCOUPLE WIRE

TYPE "K" THERMOCOUPLE WIRE

ANSI Color Code: Positive - Yellow, Negative - Red, Overall - Brown

Insulation	Insulation Temperature Rating	Gauge	Part Number	Limits of Error	Solid / Stranded
Flexible PVC Plastic, Duplex Parallel, "Ripcord" Peelable Construction	221°F (105°C)	24	LKD-24-SL-PVC-RIP	Standard	Solid
		24	LKS-24-SL-PVC-RIP	Special	Solid
Extruded Flexible Teflon® FEP Plastic, Duplex Parallel, Extruded FEP Jacket	400°F (204°C)	20	LKD-20-SL-FEP-FEP	Standard	Solid
		20	LKS-20-SL-FEP-FEP	Special	Solid
		20	LKD-20-ST-FEP-FEP	Standard	Stranded
		24	LKD-24-SL-FEP-FEP	Standard	Solid
		24	LKS-24-SL-FEP-FEP	Special	Solid
		24	LKD-24-ST-FEP-FEP	Standard	Stranded
Fused TFE Tape, Duplex Parallel, TFE Tape Jacket	500°F (260°C)	20	LKD-20-SL-TFE-TFE	Standard	Solid
		20	LKS-20-SL-TFE-TFE	Special	Solid
		24	LKD-24-SL-TFE-TFE	Standard	Solid
		24	LKS-24-SL-TFE-TFE	Special	Solid
Polyimide Fused Tape, Duplex Parallel, Polyimide Fused Tape Jacket	600°F (315°C)	20	LKD-20-SL-KAP-KAP	Standard	Solid
		20	LKD-20-ST-KAP-KAP	Standard	Stranded
		20	LKS-20-SL-KAP-KAP	Special	Solid
		24	LKS-24-ST-KAP-KAP	Standard	Stranded
Polyimide Fused Tape, Twisted Pair, No Jacket	600°F (315°C)	24	LKD-24-SL-KAP-TW	Standard	Solid
Fiberglass Wrap, Duplex Parallel, Fiberglass Braided Jacket	900°F (480°C)	28	LKD-28-SL-FGW-FBG	Standard	Solid
		28	LKS-28-SL-FGW-FBG	Special	Solid
		30	LKD-30-SL-FGW-FBG	Standard	Solid
		30	LKS-30-SL-FGW-FBG	Special	Solid
Fiberglass Braid, Duplex Parallel, Fiberglass Braid Jacket	900°F (480°C)	20	LKD-20-SL-FBG-FBG	Standard	Solid
		20	LKS-20-SL-FBG-FBG	Special	Solid
		20	LKD-20-ST-FBG-FBG	Standard	Stranded
		22	LKD-22-ST-FBG-FBG	Standard	Stranded
		24	LKD-24-SL-FBG-FBG	Standard	Solid
		24	LKS-24-SL-FBG-FBG	Special	Solid
		24	LKD-24-ST-FBG-FBG	Standard	Stranded
Fiberglass Braid, Duplex Parallel, Fiberglass Braid Jacket, Stainless Steel Overbraid	900°F (480°C)	20	LKD-20-SL-FBG-SSB	Standard	Solid
		20	LKD-20-ST-FBG-SSB	Standard	Stranded
		22	LKD-22-ST-FBG-SSB	Standard	Stranded
High Temperature Glass Braid, Duplex Parallel, High Temperature Glass Braid Jacket	1300°F (705°C)	20	LKD-20-SL-FBH-FBG	Standard	Solid
		20	LKS-20-SL-FBH-FBG	Special	Solid
Ceramic Fiber Braid, Twisted Pair, No Jacket (CRH = Heavy Build, CRM = Medium Build)	2200°F (1205°C)	20	LKD-20-SL-CRH-CRH	Standard	Solid
		20	LKS-20-SL-CRH-CRH	Special	Solid
		20	LKD-20-SL-CRM-CRM	Standard	Solid
		20	LKS-20-SL-CRM-CRM	Special	Solid



*closing the loop on thermal solutions*

## INSULATED THERMOCOUPLE WIRE

### TYPE "T" THERMOCOUPLE WIRE

ANSI Color Code: Positive - Blue, Negative - Red, Overall - Brown

Insulation	Insulation Temperature Rating	Gauge	Part Number	Limits of Error	Solid / Stranded
Flexible PVC Plastic, Duplex Parallel, Ripcord™ Peelable Construction	221°F (105°C)	24	LTD-24-SL-PVC-RIP	Standard	Solid
		24	LTS-24-SL-PVC-RIP	Special	Solid
Extruded Flexible Teflon® FEP Plastic, Duplex Parallel, Extruded FEP Jacket	400°F (204°C)	20	LTD-20-SL-FEP-FEP	Standard	Solid
		20	LTS-20-SL-FEP-FEP	Special	Solid
		20	LTD-20-ST-FEP-FEP	Standard	Stranded
		24	LTD-24-SL-FEP-FEP	Special	Solid
		30	LTS-30-SL-FEP-FEP	Special	Solid
Flexible FEP Plastic, Twisted Pair with Aluminum Shield and Copper Drain Wire, FEP Jacket	400°F (204°C)	20	LTD-20-SL-FEP-FEPS	Standard	Solid
Fused TFE Tape, Duplex Parallel, TFE Tape Jacket	500°F (260°C)	20	LTS-20-SL-TFE-TFE	Special	Solid
		24	LTD-24-SL-TFE-TFE	Standard	Solid
Fiberglass Braid, Duplex Parallel, Fiberglass Braided Jacket	900°F (480°C)	20	LTD-20-SL-FBG-FBG	Standard	Solid
		24	LTD-24-SL-FBG-FBG	Standard	Solid

### TYPE "JX" THERMOCOUPLE EXTENSION WIRE

ANSI Color Code: Positive - White, Negative - Red, Overall - Brown

Insulation	Insulation Temperature Range	Gauge	Part Number	Limits of Error	Solid / Stranded
Flexible PVC Plastic, Duplex Parallel, PVC Jacket	221°F (105°C)	16	LJX-16-SL-PVC-PVC	Standard	Solid
		20	LJX-20-SL-PVC-PVC	Standard	Solid
		20	LJX-20-ST-PVC-PVC	Standard	Stranded
Flexible PVC Plastic, Twisted Pair with Aluminum Shield and Copper Drain Wire, PVC Jacket	221°F (105°C)	16	LJX-16-SL-PVC-PVCS	Standard	Solid
		20	LJX-20-SL-PVC-PVCS	Standard	Solid
		20	LJX-20-ST-PVC-PVCS	Standard	Stranded
Flexible PVC Plastic, 4 Twisted Pairs, PVC Jacket with Aluminum Shield and Copper Drain Wire	221°F (105°C)	20	LJX-20-SL-PVC-PVCS-4PR	Standard	Solid
Flexible PVC Plastic, 8 Twisted Pairs, PVC Jacket with Aluminum Shield and Copper Drain Wire	221°F (105°C)	20	LJX-20-SL-PVC-PVCS-8PR	Standard	Solid
Flexible FEP Plastic, Duplex Parallel, FEP Jacket	400°F (204°C)	20	LJX-20-SL-FEP-FEP	Standard	Solid
Flexible FEP Plastic, Twisted Pair with Aluminum Shield and Copper Drain Wire, FEP Jacket	400°F (204°C)	16	LJX-16-SL-FEP-FEPS	Special	Solid
		20	LJX-20-SL-FEP-FEPS	Standard	Solid
Fiberglass Braid, Duplex Parallel, Fiberglass Braided Jacket	900°F (480°C)	16	LJX-16-SL-FBG-FBG	Standard	Solid



closing the loop on thermal solutions

## INSULATED THERMOCOUPLE WIRE

### TYPE "KX" THERMOCOUPLE EXTENSION WIRE

ANSI Color Code: Positive - Yellow, Negative - Red, Overall - Brown

Insulation	Insulation Temperature Rating	Gauge	Part Number	Limits of Error	Solid / Stranded
Flexible PVC Plastic, Duplex Parallel, PVC Jacket	221°F (105°C)	16	LKX-16-SL-PVC-PVC	Standard	Solid
		20	LKX-20-SL-PVC-PVC	Standard	Solid
		20	LKX-20-ST-PVC-PVC	Standard	Stranded
Flexible PVC Plastic, Twisted Pair with Aluminum Shield and Copper Drain Wire, PVC Jacket	221°F (105°C)	16	LKX-16-SL-PVC-PVCS	Standard	Solid
		20	LKX-20-SL-PVC-PVCS	Standard	Solid
		20	LKX-20-ST-PVC-PVCS	Standard	Stranded
Flexible PVC Plastic, 4 Twisted Pairs, PVC Jacket with Aluminum Shield and Copper Drain Wire	221°F (105°C)	20	LKX-20-SL-PVC-PVCS-4PR	Standard	Solid
Flexible PVC Plastic, 8 Twisted Pairs, PVC Jacket with Aluminum Shield and Copper Drain Wire	221°F (105°C)	20	LKX-20-SL-PVC-PVCS-8PR	Standard	Solid
Flexible FEP Plastic, Duplex Parallel, FEP Jacket	400°F (204°C)	20	LKX-20-SL-FEP-FEP	Standard	Solid
Flexible FEP Plastic, Twisted Pair with Aluminum Shield and Copper Drain Wire, FEP Jacket	400°F (204°C)	16	LKX-16-SL-FEP-FEPS	Standard	Solid
		20	LKX-20-SL-FEP-FEPS	Standard	Solid

### TYPE "TX" THERMOCOUPLE EXTENSION WIRE

ANSI Color Code: Positive - Blue, Negative - Red, Overall - Brown

Insulation	Insulation Temperature Rating	Gauge	Part Number	Limits of Error	Solid / Stranded
Flexible PVC Plastic, Duplex Parallel, PVC Jacket	221°F (105°C)	16	LTX-16-SL-PVC-PVC	Standard	Solid
		20	LTX-20-SL-PVC-PVC	Standard	Solid
		20	LTX-20-ST-PVC-PVC	Standard	Stranded
Flexible PVC Plastic, Twisted Pair with Aluminum Shield and Copper Drain Wire, PVC Jacket	221°F (105°C)	16	LTX-16-SL-PVC-PVCS	Standard	Solid
		20	LTX-20-SL-PVC-PVCS	Standard	Solid
		20	LTX-20-ST-PVC-PVCS	Standard	Stranded
Flexible PVC Plastic, 4 Twisted Pairs, PVC Jacket with Aluminum Shield and Copper Drain Wire	221°F (105°C)	20	LTX-20-SL-PVC-PVCS-4PR	Standard	Solid
Flexible PVC Plastic, 8 Twisted Pairs, PVC Jacket with Aluminum Shield and Copper Drain Wire	221°F (105°C)	20	LTX-20-SL-PVC-PVCS-8PR	Standard	Solid
Flexible FEP Plastic, Duplex Parallel, FEP Jacket	400°F (204°C)	20	LTX-20-SL-FEP-FEP	Standard	Solid
Flexible FEP Plastic, Twisted Pair with Aluminum Shield and Copper Drain Wire, FEP Jacket	400°F (204°C)	16	LTX-16-SL-FEP-FEPS	Standard	Solid
		20	LTX-20-SL-FEP-FEPS	Standard	Solid





*closing the loop on thermal solutions*

## INSULATED THERMOCOUPLE WIRE

### TYPE "TX" THERMOCOUPLE EXTENSION WIRE

ANSI Color Code: Positive - Blue, Negative - Red, Overall - Blue

Insulation	Insulation Temperature Rating	Gauge	Part Number	Nominal Size	Solid / Stranded
PVC Duplex-Parallel Extruded Jacket	221°F (105°C)	16	TX16-PP0	.115 x .190	Solid
		20	TX20-PP0	.095 x .158	Solid
		20	TFX20-PP0	.113 x .182	Stranded
PVC Duplex Twisted Shield with Drain Extruded Jacket	221°F (105°C)	16	TX16-PTD0	.070 x .120	Stranded
		20	TX20-PTD0	.045 x .080	Solid
Extruded Teflon® FEP Duplex Twisted Shield with Drain Extruded Jacket	400°F (204°C)	16	TX16-ETD0	.075 x .120	Solid
		20	TX20-ETD0	.080 x .160	Stranded

### TYPE "EX" THERMOCOUPLE EXTENSION WIRE

ANSI Color Code: Positive - Purple, Negative - Red, Overall - Purple

Insulation	Insulation Temperature Rating	Gauge	Part Number	Nominal Size	Solid / Stranded
PVC Duplex-Parallel Extruded Jacket	221°F (105°C)	20	EX20-PP0	.095 X .158	Solid
PVC Duplex-Twisted Extruded Jacket	221°F (105°C)	20	EXF20-PT0	.180	Stranded
PVC Duplex Twisted Shield with Drain Extruded Jacket	221°F (105°C)	16	EX16-PTD0	.220	Solid
		20	EX20-PTD0	.184	Solid

### TYPE "NX" THERMOCOUPLE EXTENSION WIRE

ANSI Color Code: Positive - Orange, Negative - Red, Overall - Orange

Insulation	Insulation Temperature Rating	Gauge	Part Number	Nominal Size	Solid / Stranded
PVC Duplex-Parallel Extruded Jacket	221°F (105°C)	20	NX20-PP0	.095 x .158	Solid



closing the loop on thermal solutions

## INSULATED THERMOCOUPLE WIRE

TYPE "RX" or "SX" THERMOCOUPLE EXTENSION WIRE

ANSI Color Code: Positive - Black, Negative - Red, Overall - Green

Insulation	Insulation Temperature Rating	Gauge	Part Number	Nominal Size	Solid / Stranded
PVC Duplex-Parallel Extruded Jacket	221°F ( 105°C)	16	R,SX16-PP0	.115 x .190	Solid
		20	R,SX20-PP0	.095 x .158	Solid
Glass Braid Duplex-Parallel Braided Jacket SS Protective Overbraid	221°F ( 105°C)	16	R,SX16-PTD0	.220	Solid
		20	R,SX20-PTD0	.184	Solid
Extruded Teflon® FEP Duplex-Parallel Extruded Jacket	400°F (105°C)	16	R,SX16-ET0	.085 x .155	Solid
		20	R,SX20-ET0	.065 x .110	Solid
Teflon® TFE Fused Tape Duplex-Parallel Fused Tape Jacket	*500°F (260°C)	16	R,SX16-TT0	.085 x .155	Solid
Extruded Teflon® FEP Duplex Twisted Shield with Drain Extruded Jacket	400°F (105°C)	16	R,SX16-ETD0	.220	Solid
		20	R,SX20-ETD0	.131	Solid
Glass Braid Duplex-Parallel Braided Jacket	*900°F (482°C)	16	R,SX16-GG0	.110 x .160	Solid
		20	R,SX20-GG0	.060 x .100	Solid
		24	R,SX24-GG0	.045 x .080	Solid

\*Extension wire limit is 400°F (204°C)

TYPE "BX" THERMOCOUPLE EXTENSION WIRE (Alloy PCLW630 vs. Copper)

ANSI Color Code: Positive - Gray, Negative - Red, Overall - Gray

Insulation	Insulation Temperature Rating	Gauge	Part Number	Nominal Size	Solid / Stranded
Glass Braid Duplex-Parallel Braided Jacket	*900°F (482°C)	20	BX20-GG0	.060 x .100	Solid

\*Extension wire limit is 400°F (204°C)

TYPE "CX" THERMOCOUPLE EXTENSION WIRE (Alloy 405 vs. Alloy 426)

ANSI Color Code: Positive - Orange, Negative - Red, Overall - Orange/Black

Insulation	Insulation Temperature Rating	Gauge	Part Number	Nominal Size	Solid / Stranded
Glass Braid Duplex-Parallel Braided Jacket	*900°F (482°C)	20	CX20-GG0	.050 x .090	Solid

\*Extension wire limit is 400°F (204°C)

## THERMOCOUPLE CONNECTIONS

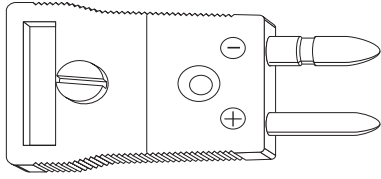

Plug

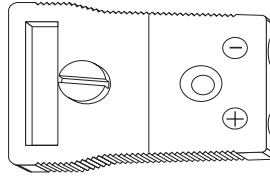

Jack

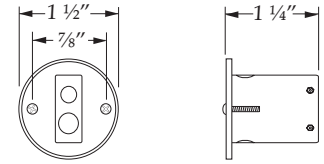

Fits Standard 1/2" Knockout  
Circular Panel Jack

Calibration	Color	Plug Number	Jack Number	Circular Jack
J	Black	096005	106005	104017
K	Yellow	096006	106006	104018
T	Blue	096008	106008	104002
E	Purple	096007	106007	106040
R/S	Green	096009	106009	106041
CU	White	096010	106010	104026

Note: Standard temperature rating is 400°F. High temperature available at 550°F.

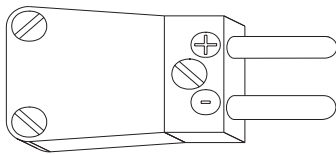

Mini Plug

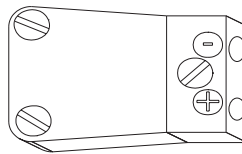

Mini Jack

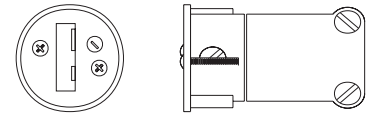

Mini Circular Panel Jack

Calibration	Color	Plug Number	Jack Number	Circular Jack
J	Black	096017	106017	104021
K	Yellow	096018	106018	104023
T	Blue	096020	106020	106042
E	Purple	096019	106019	106043
R/S	Green	096021	106021	106044
CU	White	096022	106022	106023

Note: Standard temperature rating is 400°F. High temperature available at 550°F.

## PANEL JACK STRIPS

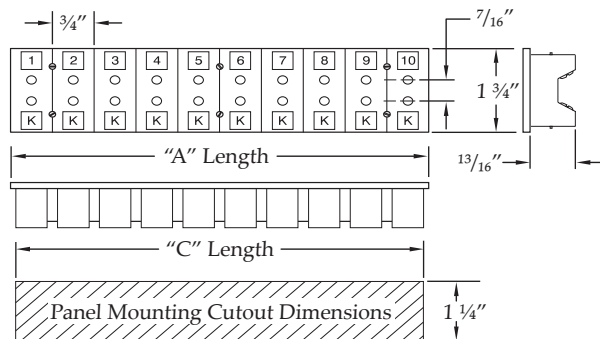

Panel Length	Number of Circuits	Cutout Dim. "C"
1 1/2"	2	1 5/16"
2 1/4"	3	2 1/16"
3"	4	2 13/16"
3 3/4"	5	3 9/16"
4 1/2"	6	4 5/16"
5 1/4"	7	5 1/16"
6"	8	5 13/16"
6 3/4"	9	6 9/16"
7 1/2"	10	7 5/16"
8 1/4"	11	8 1/16"
9"	12	8 13/16"

### Part Number Sequence

PS	E, J, K, or T	Table Above
Design	Calibration Type	Number of Circuits

PS K 9

## THERMOCOUPLE ACCESSORIES

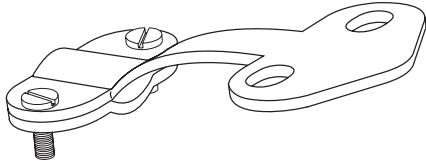

**Cable Clamp**

Part #	Type
116009	Overbraid or Armor Cable



**Stainless Steel Armor Cable**

Part #	Size
084001	1/8" ID x .210" OD
084007	5/32" ID x .234" OD
084002	3/16" ID x 9/32" OD
082002	1/4" ID x 11/32" OD
082004	3/8" ID x 1/2" OD
082006	1/2" ID x 5/8" OD

## TERMINAL BLOCKS

239000

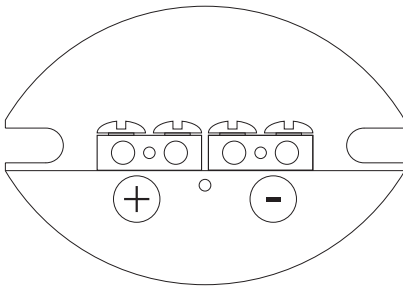

**SB100 Single Block**

234002

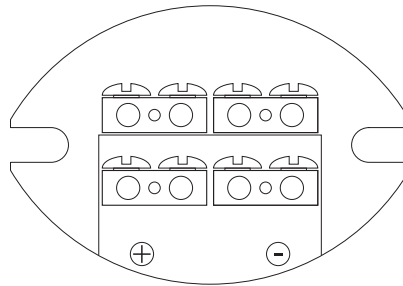

**DB100 Duplex Block**

239011

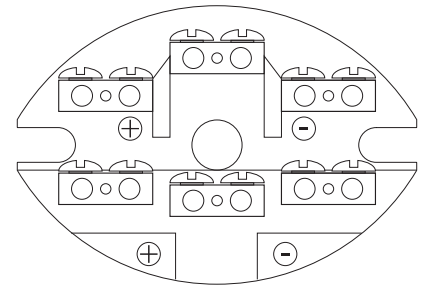

**TB100 Triplex Block**

## TERMINAL HEADS

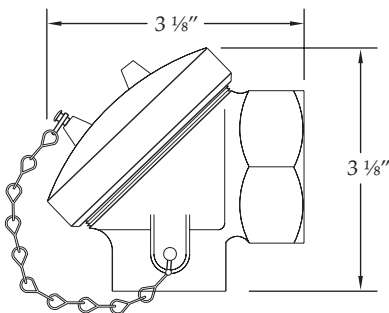

**Cast Iron Terminal Head**

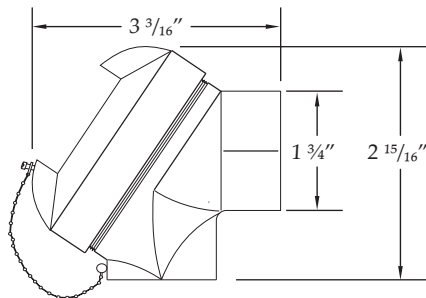

**Cast Aluminum Terminal Head**

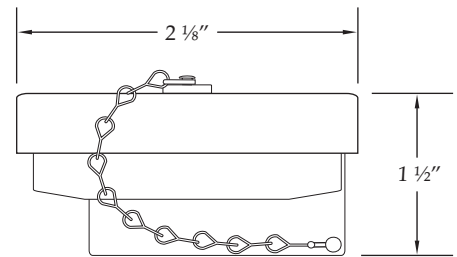

**Miniature Plastic Terminal Head**

Part #	Process Connection x Conduit Connection
229002	1/2" NPT x 3/4" NPT
229003	3/4" NPT x 3/4" NPT
229001	1" NPT x 3/4" NPT

Part #	Process Connection x Conduit Connection
224003	1/2" NPT x 3/4" NPT
226038	3/4" NPT x 3/4" NPT
229004	1" NPT x 3/4" NPT

Part #	Process Connection x Conduit Connection
224004	1/4" NPT x 1/4" NPT
226429	3/8" NPT x 1/4" NPT

## COMPRESSION FITTINGS

Compression fittings allow for the exact immersion depth to be set on the thermocouple during field installation. When ordered as part of a thermocouple assembly, the fittings will be assembled finger-tight to the sheath. The compression fittings are rated up to 10,000 psi dependent upon the sheath diameter, thread size, material and temperature requirement.

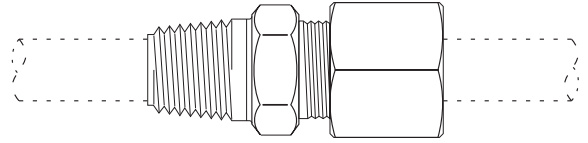

316 SS* Code	Brass* Code	Sheath Diameter	Male NPT	Finger-tight Length	Threaded Length
144001	144011	1/16"	1/16"	15/16"	3/8"
144002	144012	1/16"	1/8"	63/64"	3/8"
144003	144013	1/8"	1/8"	1 11/64"	3/8"
144004	144014	1/8"	1/4"	1 3/8"	9/16"
144005	144015	3/16"	1/8"	1 7/32"	3/8"
144006	144016	3/16"	1/4"	1 27/32"	9/16"
144007	144017	1/4"	1/4"	1 31/64"	9/16"
144008	144018	5/16"	1/4"	1 33/64"	9/16"
144009	144019	3/8"	1/4"	1 37/64"	9/16"
144010	144020	3/8"	1/2"	1 51/64"	3/4"

\*Additional materials: Steel, Aluminum, Monel, Nylon, TPE

Adjustable compression fittings are available upon request with 500°F (260°C) Teflon® sealant.

## BLANK BOLTS

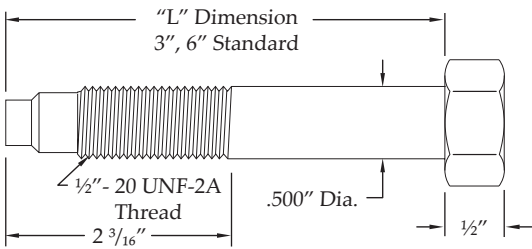

Part Number	"L" Dimension
244008	3"
244009	6"

Blank bolt occupies hole when melt bolt is removed.

## BAYONET ADAPTER

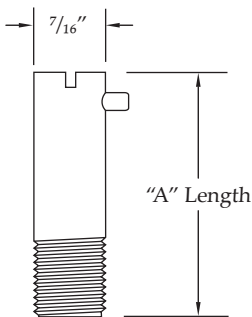

Bayonet Number	"A" Length	Thread Size
194001	7/8"	1/8 - 27 NPT
194032	1 1/8"	1/8 - 27 NPT
194002	1 1/2"	1/8 - 27 NPT
194031	2"	1/8 - 27 NPT
194003	2 1/2"	1/8 - 27 NPT
194004	3 1/4"	1/8 - 27 NPT
194005	7/8"	3/8 - 24 NF
194007	2 1/2"	3/8 - 24 NF

## TERMINAL BARRIER STRIPS

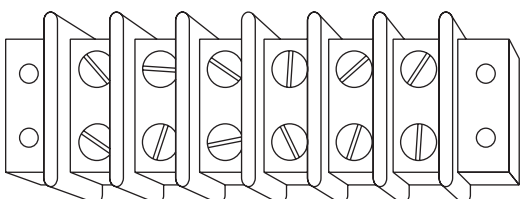

- Terminal Jumper (Positive) (CH) Chromel (IR) Iron
- Terminal Jumper (Negative) (AL) Alumel (CO) Constantan

Thermocouple Type Codes				Limits of Error
E	J	K	T	Standard Limits
2	3	4	8	Special Limits

# of screws	2	4	6	8	10	12	14	16	18	20
-------------	---	---	---	---	----	----	----	----	----	----

Note: Add Design Number and Thermocouple Type CODE to number of screws for part number. Ex: TRMS-J-4

## 2-WIRE PROGRAMMABLE TRANSMITTERS

### 5331D Features:

- RTD, Thermocouple, Ohm, or mV input
- Extremely high measurement accuracy
- 1.5 kVAC galvanic isolation
- Programmable sensor error value
- For DIN form B sensor head mounting

### 5333D Features:

- RTD or Ohm input
- High measurement accuracy
- 3-wire connection
- Programmable sensor error value
- For DIN form B sensor head mounting



### 5334B Features:

- Thermocouple input
- High measurement accuracy
- Galvanic isolation
- Programmable sensor error value
- For DIN form B sensor head mounting

### Typical Applications:

- Linearised temperature measurement with Pt100 - Pt1000, Ni100 - Ni1000, or thermocouple sensor.
- Conversion of linear resistance variation to a standard analogue current signal, for instance from valves or Ohmic level sensors.
- Amplification of a bipolar mV signal to a standard 4-20 mA current signal.

### Technical Characteristics:

- Within a few seconds the user can program the transmitter to measure temperatures within all ranges defined by the norms.
- The RTD and resistance inputs have cable compensation for 2-, 3-, and 4-wire connection.
- Continuous check of vital stored data for safety reasons.
- Cold junction compensation (CJC) with a built-in temperature sensor. (Transmitter 5334B)

### Mounting and Installation:

- For DIN form B sensor head mounting
- NB: As Ex barrier we recommend 5104B, 5114B, or 5116B



## 2-WIRE PROGRAMMABLE TRANSMITTERS

### Transmitter 5331D

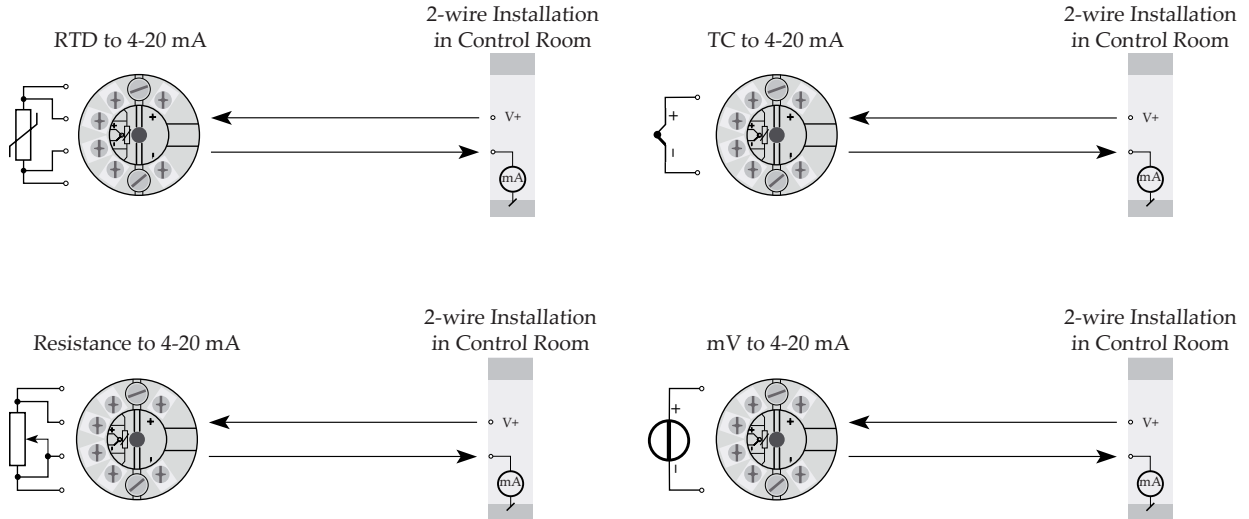

### Transmitter 5333D

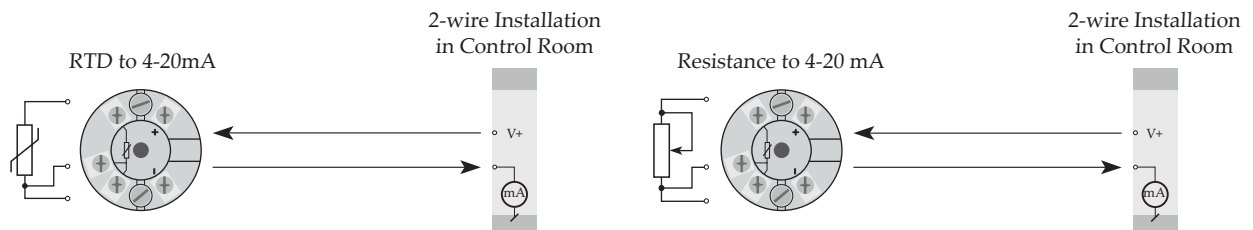

### Transmitter 5334B

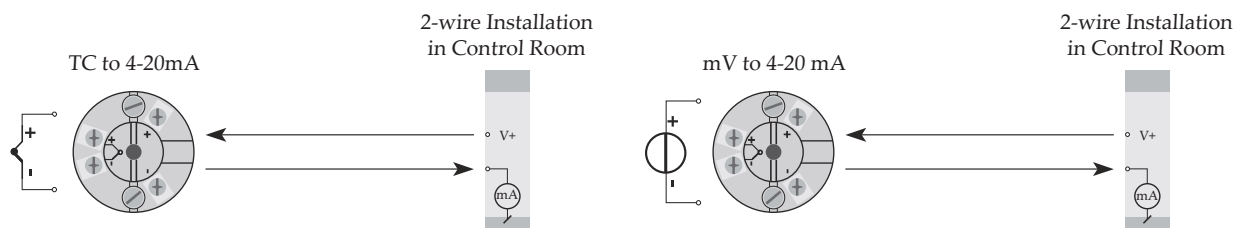

## 2-WIRE PROGRAMMABLE TRANSMITTER 5331D

### Connections:

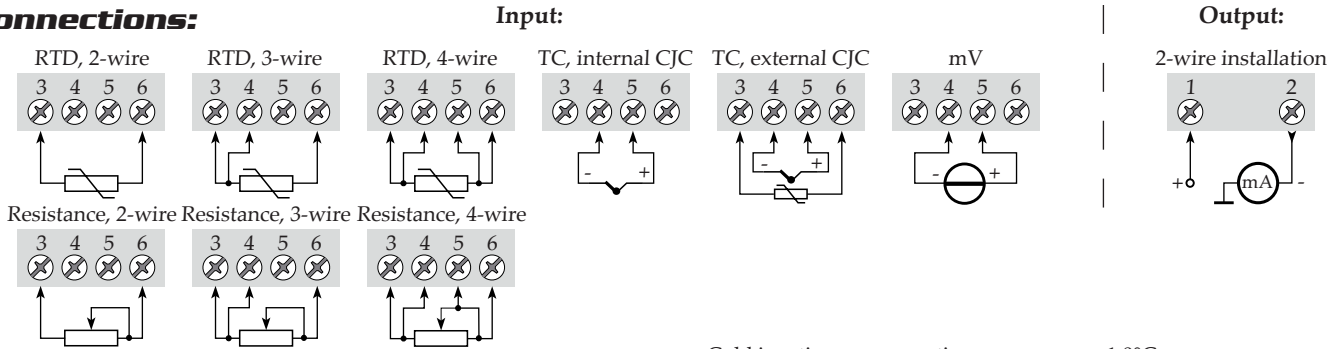

### Electrical Specifications:

#### Specifications range:

-40°C to +85°C

#### Common Specifications:

- Supply voltage, DC ..... 7.2 - 30 V
- Voltage drop ..... 7.2 VDC
- Isolation voltage, test/operation ..... 1.5 kVAC / 50 VAC
- Communications interface ..... Loop Link
- Signal/noise ratio ..... Minimum 60 dB
- Signal dynamics, input ..... 20 bit
- Signal dynamics, output ..... 16 bit
- Accuracy, the greater of general and basic values:

#### General Values

Input Type	Absolute Accuracy	Temperature Coefficient
All	≤ ± 0.05% of span	≤ ± 0.01% of span / °C

#### Basic Values

Input Type	Absolute Accuracy	Temperature Coefficient
RTD	≤ ± 0.2°C	≤ ± 0.01% °C / °C
Lin. R	≤ ± 0.1 Ω	≤ ± 10 mΩ / °C
Volt	≤ ± 10 μV	≤ ± 1 μV / °C
TC Type: E, J, K, L, N, T, U	≤ ± 1°C	≤ ± 0.05°C / °C
TC Type: B, R, S, W3, W5, LR	≤ ± 2°C	≤ ± 0.2°C / °C

- EMC immunity influence ..... < ± 0.5% of span
- Extended EMC immunity:
- NAMUR NE 21, A criterion, burst ..... < ± 1% of span
- Vibration ..... IEC 60068-2-6 Test FC
- Lloyd's specification no. 1 ..... 4 g / 2-100 Hz
- Humidity ..... < 95% RH (non-cond.)
- Dimensions ..... Ø 44 x 20.2 mm
- Protection degree (encl. / terminal) ..... IP68 / IP00
- Electrical specifications, input:**
- Max. offset ..... 50% of select. max. value

#### TC Input

Type	Min. Temp.	Max. Temp.	Min. Span	Standard
B	+400°C	+1820°C	100°C	IEC584
E	-100°C	+1000°C	50°C	IEC584
J	-100°C	+1200°C	50°C	IEC584
K	-180°C	+1372°C	50°C	IEC584
L	-100°C	+900°C	50°C	DIN 43710
N	-180°C	+1300°C	50°C	IEC584
R	-50°C	+1760°C	100°C	IEC584
S	-50°C	+1760°C	100°C	IEC584
T	-200°C	+400°C	50°C	IEC584
U	-200°C	+600°C	50°C	DIN 43710
W3	0°C	+2300°C	100°C	ASTM E988-90
W5	0°C	+2300°C	100°C	ASTM E988-90
LR	-200°C	+800°C	50°C	GOST 3044-84

Cold junction compensation ..... < ± 1.0°C

#### RTD and Linear Resistance Input

RTD Type	Min. Value	Max. Value	Min. Span	Standard
Pt100	-200°C	+850°C	25°C	IEC 60751
Ni100	-60°C	+250°C	25°C	DIN 43760
Lin. R	0 Ω	5000 Ω	30 Ω	----

- Cable resistance per wire (max.) ..... 5 Ω
- Sensor current ..... Nom. 0.2 mA

#### Voltage input:

- Measurement range ..... -12 - 800 mV
- Min. span ..... 5 mV

#### Current output:

- Signal range ..... 4 - 20 mA
- Min. signal range ..... 16 mA
- Updating time ..... 440 ms
- Load resistance ..... ≤ (Vsupply - 7.2) / 0.023 [Ω]

#### Sensor error detection:

- Programmable ..... 3.5 - 23 mA

#### Ex / I.S. approval:

- KEMA 06ATEX0062 ..... II 1 G Ex ia IIC  
T4 or T6  
II 1 D Ex ia D
- Max. ambient temp. for T1-T4 ..... 85°C
- Max. ambient temp. for T5 and T6 ..... 60°C

- ATEX, applicable in zone ..... 0, 1, 2, 20, 21 or 22
- ATEX Installation Drawing No. .... 5331QA01

- FM, applicable in ..... IS, Class 1, Div. 1  
Group A, B, C, D  
Ex ia IIC  
IS, Class 1, Zone 0  
AEx ia IIC
- FM Installation Drawing No. .... 5300Q502
- CSA, applicable in ..... IS, Class 1, Div. 1  
Group A, B, C, D  
Ex ia IIC  
IS, Class 1, Zone 0  
AEx ia IIC
- CSA Installation Drawing No. .... 533XQC03

#### Marine approval:

- Det Norske Veritas, Ships & Offshore. Stand. f. Certific. No. 2.4

#### GOST R approval:

- VNIIM & VNIIFTRI, Cert. no. .... www.prelectronics.com

#### Observed authority requirements: Standard:

- EMC 2004/108/EC ..... EN 61326-1
- ATEX 94/9/EC ..... EN 60079-0, -11, -26  
EN61241-0, -11
- FM ..... 3600, 3611, 3610
- CSA, CAN / CSA ..... C22.2 No. 157,  
E60079-11, UL 913

Of span = Of the presently selected range



## 2-WIRE PROGRAMMABLE TRANSMITTER 5333D

### Connections:

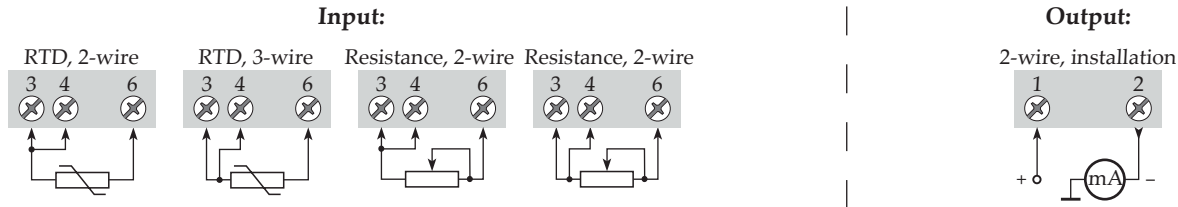

### Electrical Specifications:

Specifications range:  
-40°C to +85°C

#### Common Specifications:

Supply voltage, DC ..... 8.0 - 30 V  
Internal consumption ..... 25 mW - 0.8 W  
Voltage drop ..... 8 VDC  
Warm-up time ..... 5 min.  
Communications interface ..... Loop Link  
Signal/noise ratio ..... Minimum 60 dB  
Response time (programmable) ..... 0.33 - 60 sec.  
Signal dynamics, input ..... 19 bit  
Signal dynamics, output ..... 16 bit  
Calibration temperature ..... 20 - 28°C  
Accuracy, the greater of general and basic values:

#### General Values

Input Type	Absolute Accuracy	Temperature Coefficient
All	≤ ± 0.1% of span	≤ ± 0.01% of span / °C

#### Basic Values

Input Type	Absolute Accuracy	Temperature Coefficient
RTD	≤ ± 0.3°C	≤ ± 0.01% °C / °C
Lin. R	≤ ± 0.2 Ω	≤ ± 20 mΩ / °C

EMC immunity influence ..... < ± 0.5% of span  
Effect of supply voltage variation ..... ≤ 0.005% of span / VDC  
Vibration ..... IEC 60068-2-6 Test FC  
Lloyd's specification no. 1 ..... 4 g / 2-100 Hz  
Maximum wire size ..... 1 x 1.5 mm<sup>2</sup> stranded wire  
Humidity ..... < 95% RH (non-cond.)  
Dimensions ..... Ø 44 x 20.2 mm  
Protection degree (encl. / terminal) ..... IP68 / IP00  
Weight ..... 50 g

#### Electrical specifications, input:

Max. offset ..... 50% of select. max. value

#### RTD and Linear Resistance Input:

RTD Type	Min. Value	Max. Value	Min. Span	Standard
Pt100	-200°C	+850°C	25°C	IEC 60751
Ni100	-60°C	+250°C	25°C	DIN 43760
Lin. R	0 Ω	10,000 Ω	30 Ω	----

Cable resistance per wire (max.) ..... 10 Ω  
Sensor current ..... > 0.2 mA, < 0.4 mA  
Effect of sensor cable resistance (3-wire) < 0.002 Ω / Ω  
Sensor error detection ..... Yes

#### Output:

##### Current output:

Signal range ..... 4 - 20 mA  
Min. signal range ..... 16 mA  
Updating time ..... 135 ms  
Load resistance ..... ≤ (Vsupply - 8) / 0.023 [Ω]

##### Sensor error detection:

Programmable ..... 3.5 - 23 mA  
Namur NE43 Upscale ..... 23 mA  
Namur NE43 Downscale ..... 3.5 mA

##### Ex / I.S. approval:

KEMA 03ATEX1535 X ..... II 1 GD, T80-105°C  
EEx ia IIC T6 / T4

Max. ambient temp. for T1-T4 ..... 85°C  
Max. ambient temp. for T5 and T6 ..... 60°C  
ATEX, applicable in zone ..... 0, 1, 2, 20, 21 or 22

##### Ex / I.S. data:

Signal output / supply, terminal 1-2:

U<sub>i</sub> ..... 30 VDC  
I<sub>i</sub> ..... 120 mADC  
P<sub>i</sub> ..... 0.84 W  
L<sub>i</sub> ..... 10 μH  
C<sub>i</sub> ..... 1.0 nF

Sensor input, terminal 3, 4 and 6:

U<sub>o</sub> ..... 27 VDC  
I<sub>o</sub> ..... 7 mA  
P<sub>o</sub> ..... 45 mW  
L<sub>o</sub> ..... 34 mH  
C<sub>o</sub> ..... 90 nF

FM, applicable in ..... IS, Class 1, Div. 1  
Group A, B, C, D  
IS, Class 1, Zone 0  
AEx ia IIC

FM Installation Drawing No. .... 5300Q502

CSA, applicable in ..... IS, Class 1, Div. 1  
Group A, B, C, D  
IS, Class 1, Zone 0  
Ex ia IIC

CSA Installation Drawing No. .... 533XQC03

##### Marine approval:

Det Norske Veritas, Ships & Offshore.. Stand. for Certific. No. 2.4

##### GOST R approval:

VNIIM & VNIIFTRI, Cert. no. .... www. prelectronics.com

##### Observed authority requirements:

**Standard:**  
EMC 2004/108/EC ..... EN 61326-1  
ATEX 94/9/EC ..... EN 50014, EN 50020  
EN 50281-1-1, EN 50284,  
EN 61241-0, EN 61241-11  
FM ..... 3600, 3611, 3610  
CSA, CAN / CSA ..... C22.2 No. 157,  
E60079-11, UL 913

Of span = Of the presently selected range

## 2-WIRE PROGRAMMABLE TRANSMITTER 5334B

### Connections:

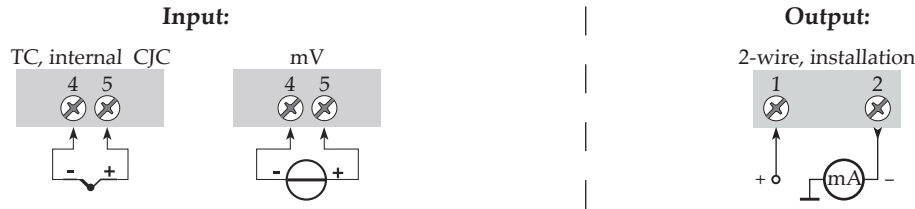

### Electrical Specifications:

Specifications range:  
-40°C to +85°C

#### Common Specifications:

Supply voltage, DC ..... 7.2 - 28 V  
Internal consumption ..... 25 mW - 0.8 W  
Voltage drop ..... 7.2 VDC  
Isolation voltage, test/operation ..... 1.5 kVAC / 50 VAC  
Communications interface ..... Loop Link 5905A  
Signal/noise ratio ..... Minimum 60 dB  
Signal dynamics, input ..... 18 bit  
Signal dynamics, output ..... 16 bit  
Accuracy, the greater of general and basic values:

#### General Values

Input Type	Absolute Accuracy	Temperature Coefficient
All	≤ ± 0.05% of span	≤ ± 0.01% of span / °C

#### Basic Values

Input Type	Absolute Accuracy	Temperature Coefficient
Volt	≤ ± 10 μV	≤ ± 1 μV / °C
TC Type: E, J, K, L, N, T, U	≤ ± 1°C	≤ ± 0.05°C / °C
TC Type: B, R, S, W3, W5	≤ ± 2°C	≤ ± 0.2°C / °C

EMC immunity influence ..... < ± 0.5% of span  
Extended EMC immunity:  
NAMUR NE 21, A criterion, burst ..... < ± 1% of span  
Effect of supply voltage variation ..... < 0.005% of span / VDC  
Vibration ..... IEC 68-2-6 Test FC  
Lloyd's specification no. 1 ..... 4 g / 2-100 Hz  
Humidity ..... < 95% RH (non-cond.)  
Dimensions ..... Ø 44 x 20.2 mm  
Tightness (enclosure / terminal) ..... IP68 / IP00

#### Electrical specifications, input:

Max. offset ..... 50% of select. max. value

#### TC Input

Type	Min. Temp.	Max. Temp.	Min. Span	Standard
B	+400°C	+1820°C	200°C	IEC584
E	-100°C	+1000°C	50°C	IEC584
J	-100°C	+1200°C	50°C	IEC584
K	-180°C	+1372°C	50°C	IEC584
L	-100°C	+900°C	50°C	DIN 43710
N	-180°C	+1300°C	100°C	IEC584
R	-50°C	+1760°C	200°C	IEC584
S	-50°C	+1760°C	200°C	IEC584
T	-200°C	+400°C	50°C	IEC584
U	-200°C	+600°C	75°C	DIN 43710
W3	0°C	+2300°C	200°C	ASTM E988-90
W5	0°C	+2300°C	200°C	ASTM E988-90

Cold junction compensation ..... < ± 1.0°C

#### Voltage input:

Measurement range ..... -12 - 150 mV  
Min. span ..... 5 mV  
Input resistance ..... 10 M Ω

#### Current output:

Signal range ..... 4 - 20 mA  
Min. signal range ..... 16 mA  
Updating time ..... 440 ms  
Load resistance ..... ≤ (Vsupply - 7.2) / 0.023 [Ω]

#### Sensor error detection:

Programmable ..... 3.5 - 23 mA  
NAMUR NE43 Upscale ..... 23 mA  
NAMUR NE43 Downscale ..... 3.5 mA

#### Ex data:

U<sub>i</sub> ..... 28 VDC  
I<sub>i</sub> ..... 120 mADC  
P<sub>i</sub> ..... 0.84 W  
L<sub>i</sub> ..... 10 μH  
C<sub>i</sub> ..... 1.0 nF

#### EEx / I.S. approval:

KEMA 03 ATEX 1536 ..... II 1 G D  
EEx is IIC T1-T6  
Max. ambient temp. for T1-T4 ..... 85°C  
Max. ambient temp. for T5 and T6 ..... 60°C  
Applicable in zone ..... 0, 1, 2, 20, 21 or 22

#### Observed authority requirements: Standard:

EMC 89/336/EEC, Emission ..... EN 50 081-1, EN 50 081-2  
Immunity ..... EN 50 082-2, EN 50 082-1  
Emission and Immunity ..... EN 61 326  
ATEX 94/9/EC ..... EN 50 014, EN 50 0020,  
EN 50 281-1-1 and EN 50 284

Of span = Of the presently selected range