

Cast-In Heaters for Plastics Processing

L-SHAPED SQUARE CAST-IN BARREL HEATERS

The "L" shape cast-in heater design is typically used on square and rectangular extruder barrels, which utilize a twin screw design. In most cases, the high operating temperatures in these applications require these cast-in heaters to be constructed of a bronze alloy, however aluminum alloys are used for applications which do not require the higher watt densities. While the most common design for "L" shaped cast-in heaters consists of heat only, they can be manufactured with cast-in cooling tubes. Typical mounting options include manufacturing the casting with 45° mounting flange which allows the cast-in heaters to be bolted and drawn together on the barrel or the cast-in heater can be supplied with mounting holes machined into the casting to mount directly to the barrel. The most common electrical termination for the "L" shape designs is a junction box mounted on to a vented tower that extends from the body of the casting. The box has a gasket for moisture resistance and can also be supplied with explosion proof specifications. The junction box can also be cast directly onto the heater. High temperature leadwire with a heavy-duty bronze braid is also available upon request.

Design Features

- Flange ear or drilled holes for mounting to the barrel
- Durable cast-in vented towers for terminal box mounting
- Manufactured in aluminum alloy for lower temperature applications
- Cooling tubes can be cast-in for liquid cooling capacity
- Machined holes for transducers and thermocouple locations

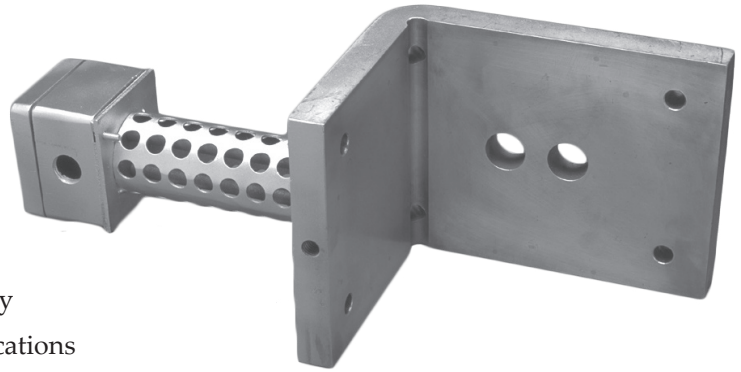

Flange Ear

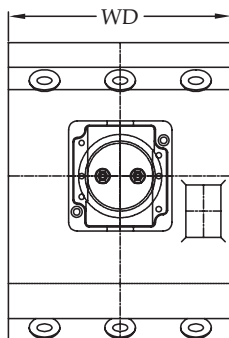
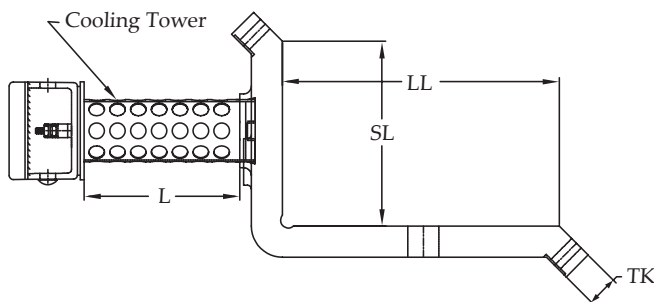

Drilling Holes

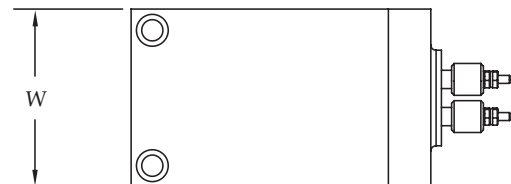
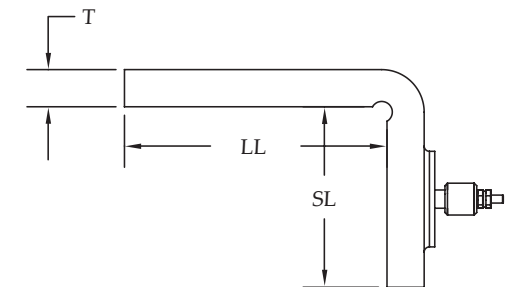

Cast-In Heater Terminations

Electrical Terminations

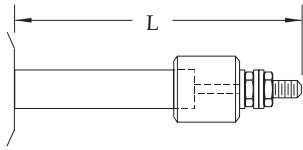

TYPE S

10-32 threaded screw terminal with ceramic insulator. Included nuts and washers.

Type S standard for cast-in heaters. 6-32, 8-32 and metric sizes also available.

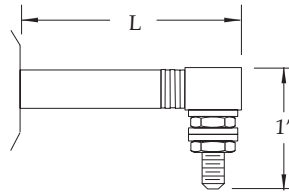

TYPE A

Right angle terminal block seated on mica washers with 10-32 threaded stud. Included nuts and washers.

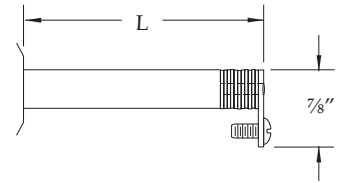

TYPE R

Screw lug terminal seated on mica washers and welded to pin. Includes 8-32 screw for wire connection.

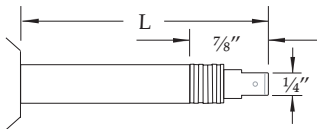

TYPE D

Quick-disconnect spade lug with 1/4" blade welded to pin. Other blade sizes available upon request.

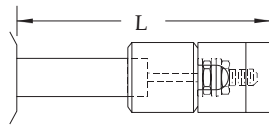

TYPE T

Ceramic insulator with ceramic top for insulation of electrical connections. Includes complete Type "S" termination with 10-32 threaded stud.

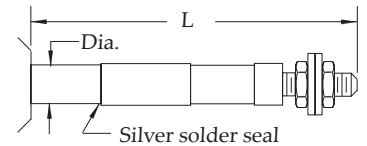

Silver solder seal

TYPE HS

Ceramic to metal hermetic seal is silver soldered directly to heating element for moisture-proof termination. 10-32 screw terminal includes nuts and washers.

Dia.	L	Thread
.430	1 1/8"	1/4-28
.315	1 3/8"	10-32
.250	1 5/8"	8-32

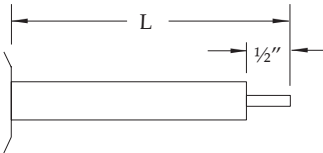

TYPE P

Plain pin for field attachment of termination. Pin length is 1/2" standard.

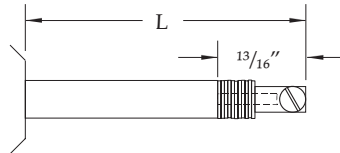

TYPE L

Terminal lug with 10-32 screw is welded directly to heater pin. Can be oriented straight or at right angle.

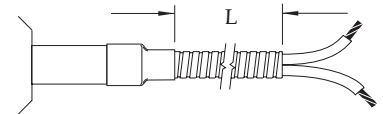

TYPE C

Flexible armor cable for abrasion resistance with high temperature leadwire attached to heating element. Specify L dimension when ordering.

Cooling Tube Terminations

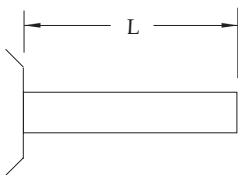

TYPE C1

Plain cooling tube cut to standard 3" length extending from heater. Specify longer length if required.

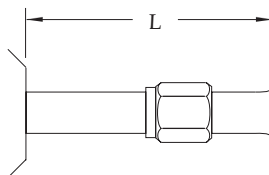

TYPE C2

37° Flare nut fitting allows for cooling tube connection to compression fitting.

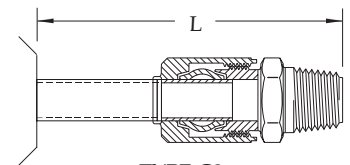

TYPE C3

Compression fitting mounted directly to cooling tube provides seal for high pressure hook up. Available in standard 3/8" and 1/2" NPT. 3/8" Dia. #55-0010 1/2" Dia. #55-0011

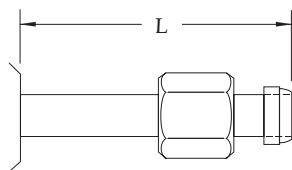

TYPE C4

Brazed seal with locknut provide an effective seal for high pressure applications. Mating fittings available upon request.

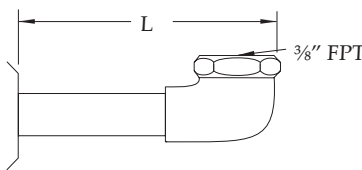

TYPE C5

Brazed angle fitting mounted directly to cooling tube with right angle 3/8" FPT as standard. Specify L dimensions.

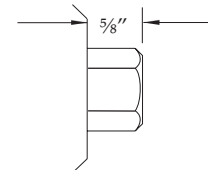

TYPE C6

Cast-in fitting with standard 5/8" FPT for quick installation of cooling lines with no additional fittings.

Cast-In Heater Protective housings

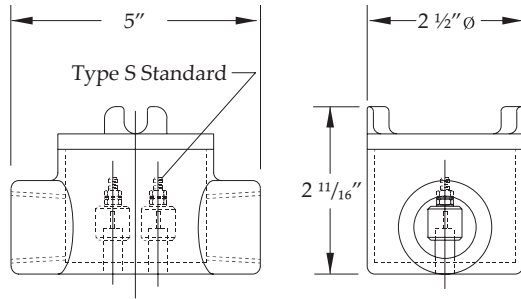

TYPE B1

Explosion proof cast iron housing with 1/2" NPT double hub. Single phase design shown. Larger housing for 3 phase design also available.

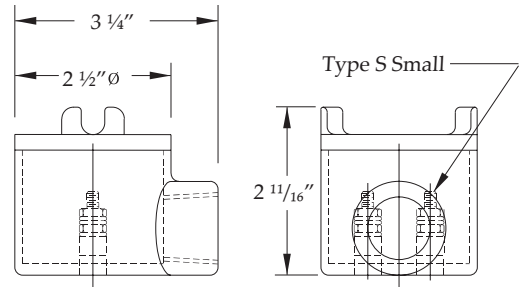

TYPE B2

Explosion proof cast iron housing with 1/2" NPT single hub. Single phase design shown. Larger housing for 3 phase design also available.

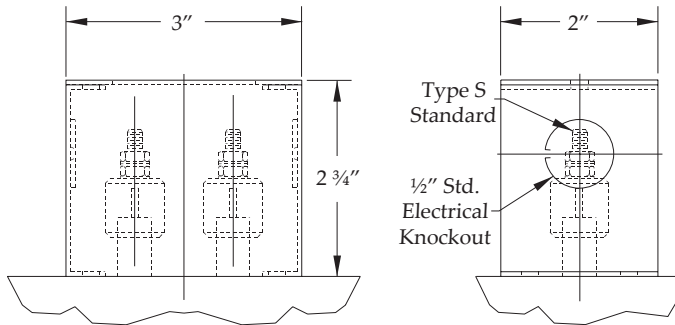

TYPE B3

Standard size stainless steel sheet metal box with two 1/2" electrical knockouts. Other sizes and types available.

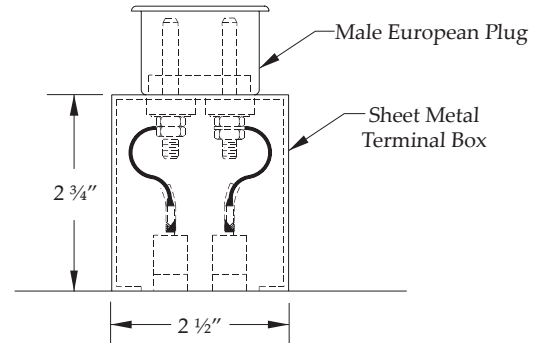

TYPE B4

Stainless steel terminal enclosure with male ERGE plug mounted on top. Mating connections available upon request.

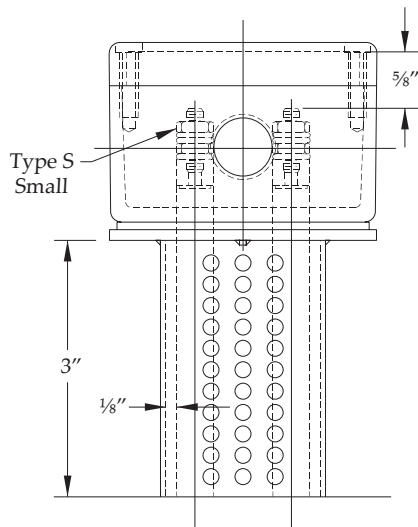

TYPE B5

Die cast aluminum enclosure with 1/2" or 3/4" threaded electrical connections mounted to vented cooling tower. Other sizes and types available for single and 3 phase designs.

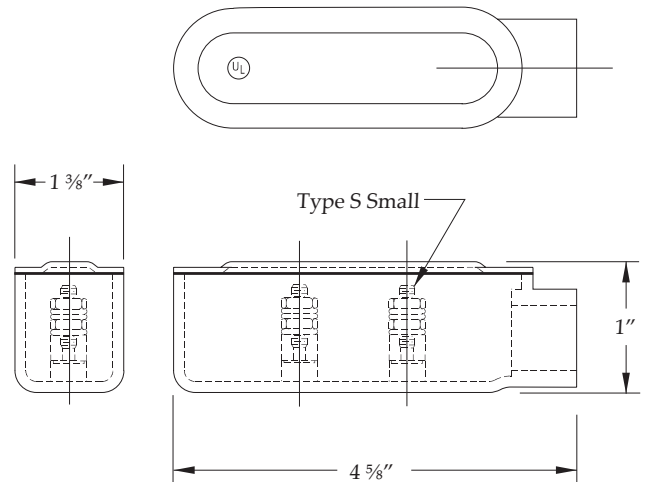

TYPE B6

Explosion resistant box with 1/2" NPT single hub, designed for low profile applications. Single phase only. Different hub configurations are available.



closing the loop on thermal solutions

Cast-In Heater Specifications & Special Services

Cast Materials	Max. Operating Temperature
Aluminum 443	800°F (427°C)
Aluminum 319/356	700°F (371°C)
Bronze / Copper alloys	1400°F (769°C)
Iron	900°F (482°C)

If required, other cast materials are available.

CAST PROCESS

Cast-In perm-molded system uses steel permanent molds. No bake sand system for special castings and short production runs.

MACHINE FINISH

CNC machining is performed for tight tolerances and complex configurations. Milled finishes are provided per specification. Belt sanding, lapping and polishing available to meet application specifications.

Standard Machine Finish Range: 64-125 rms

Fine Finish Per Specifications: 8-32 rms

Standard Flatness:

Belt Sanded: .015

Milled: ± .005

Lapped: .001

HOLES, CUTOUTS, THERMOWELLS

Mounting or clearance holes, cutouts, and thermowells for inserting temperature measurement probes, cast-in or machined per your specifications.

INSERTS

Threaded studs, precision component parts, bushings and special design parts cast accurately in place.

ELECTRICAL

Resistance tolerance NEMA standard +10% -5%.

Voltages:

Element Diameter	.200	.260	.315	.430	.475
Maximum Volts	240	240	277	600	600

(Three phase available on large heaters.)

Maximum watt densities depends on size and application.

Consult a Durex engineer.

UL COMPONENT RECOGNITION

DA series cast-in heaters are recognized per file E110394.

INSPECTION / TESTING

- Electrical per UL 499 and UL 1030
- Canadian Standard C22.2 No. 72
- Dimensional per specifications using
- Coordinate Measure Machine
- Quality standard per MIL-Q_9858A

RADIOGRAPH (X-RAY)

Confirmation of internal element configuration and casting soundness available through x-ray.

PLATING / COATING

Electroless nickel plating, anodize, Teflon® coatings and special blasted surfaces are available per customer specification.

PRESSURE TESTING

High pressure leakage testing done in-house per application requirements.

HEAT TREATING

Stress relieving and aging through heat treating available as required.

CMM INSPECTION

Coordinate Measuring Machine used for precision quality control of tight tolerance machining requirements.

HELIUM LEAK

Detect microleakage from casting body.

TEMPERATURE UNIFORMITY

Confirm heat uniformity across the finished surface.

CLASS 1000 CLEAN ROOM

Clean room assembly and packaging per class 1000 standards.

SOLIDWORKS 3D MODELING

Engineering software provides 3D models of proposed or existing product designs.

CUSTOM PACKAGING

Customer specific packaging for delicate surfaces, large multi-product shipments, or long term storage.

LIFE CYCLE TESTING

Life cycle test chamber for long term testing of uniformity and performance characteristics.

MATERIAL CERTIFICATIONS

Precise records and certifications on materials which require traceability to specific standards.

SENSOR CALIBRATION

NIST traceable calibration lab for calibration and certification of any temperature sensor requirements.

FEA ANALYSIS

Preview of proposed design construction using FEA analysis.

Cast-In Heater Installation & Operation Guidelines

1. Always ensure that cast-in heaters are properly mounted to the application to avoid warping of flat heaters or "walking" of barrel heaters. After the initial start-up, retighten the heater mounting system to assure complete surface contact. Periodically check bolts or straps and tighten as required maintenance.
2. Tighten all liquid cool connections securely to avoid rupture from internal steam pressures. Cast-in C6 fittings or brazed connections are the most reliable. Properly maintain these connections to avoid leaks that will destroy the heater. Do not operate heating and cooling simultaneously to avoid thermal shock of the cooling tubes.
3. It is recommended that water used for liquid cooling applications be treated to avoid corrosion and hard water deposits that will clog the cooling tubes over time.
4. Install proper temperature control prior to operation of the heaters to ensure protection from over-temp situations which may damage the heater or equipment. Periodically changing temperature sensors is good preventive maintenance.
5. Electrical terminals must be properly insulated and made tightly to ensure safe operation. All heater installations must be properly grounded. All electrical terminations must be made per applicable Electrical Safety Codes and O.S.H.A. regulations.
6. Do not operate the heaters outside of the rated voltage and temperature of the design. This will cause the heaters to fail.
7. Always disconnect the electrical power to heaters prior to service.

Electrical Data

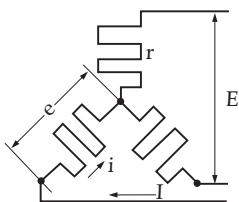

Wye or Star Connection

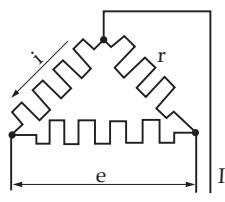

Delta Connection

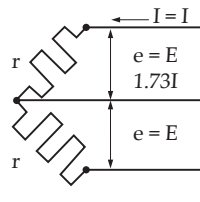

3-Phase Open Delta

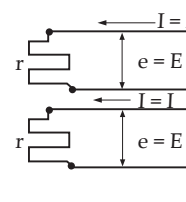

2-Phase 4 Wire

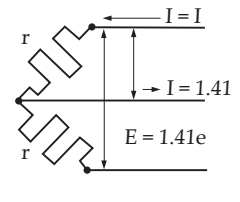

2-Phase 3 Wire

The energy put out by a heating unit is measured in watts.
The power factor is always unity.

Single Phase, $W = I^2 = EI$
Three Phase Delta, $W = 3EI = 1.73 EI$
Three Phase Wye, $W = 3eI = 1.73 EI$
Two Phase 4 Wire, $W = 2I^2R = 2 EI$
Two Phase 3 Wire, $W = 2I^2R = 2 EI$
(Voltage between outside wires = $1.41e$)

$$\text{Phase Amps} = I = \frac{W}{E \times \text{PF}}$$

$$\text{A.C., 3 Phase Amps} = I = \frac{W}{1.73 E \times \text{PF}}$$

$$\text{A.C., 2 Phase 3 Wire: Middle wire amps} = \text{Amps in outside wire} \times 1.41$$

W = Power, Watts
 E = E.M.F. Volts
 I = Current, Amperes
 R = Resistance, Ohms
 PF = Power Factor
 $\text{Amps} = I = \frac{W}{E} = \frac{E}{R}$

OHMS LAW

